

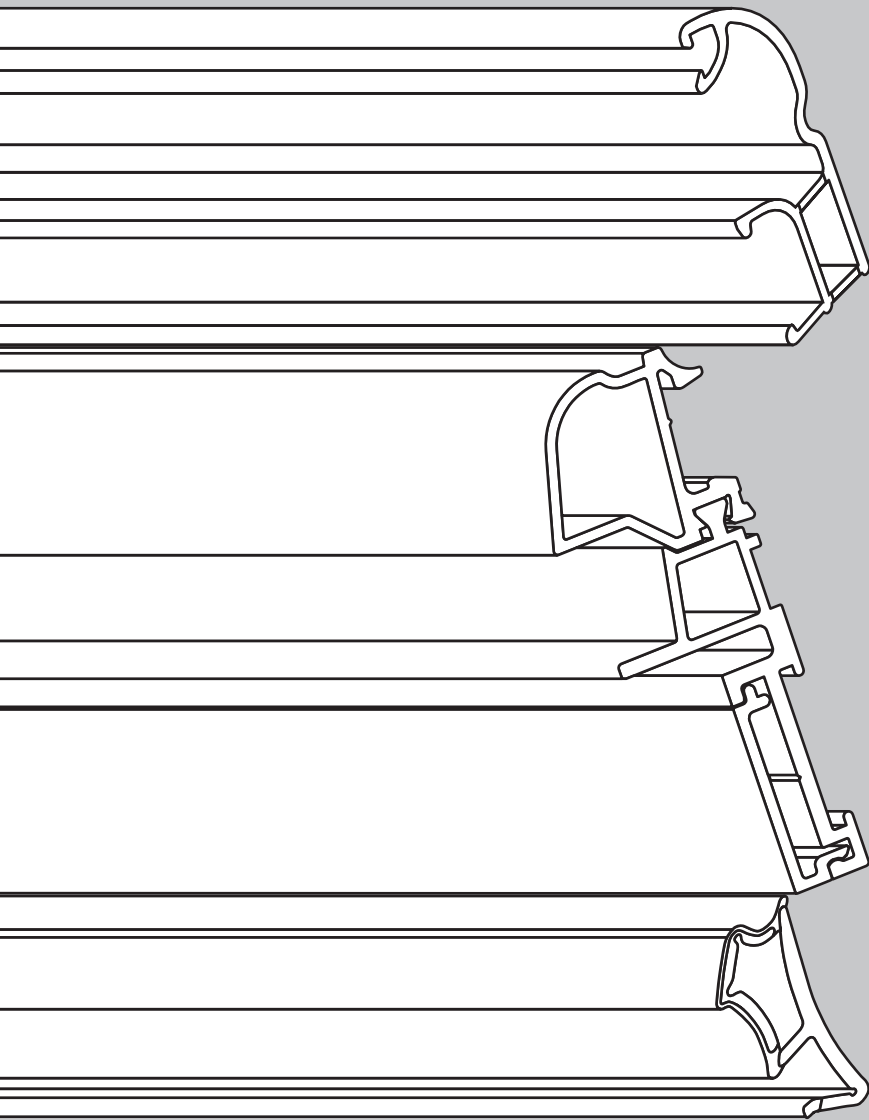

ACCESSORI
CASCADING
FREUD.



GOCCIOLATOI

SOGLIE

SOGLIE GUTMANN

GUARNIZIONI

ACCESSORI

WEATHER BARS

THRESHOLDS

GUTMANN THRESHOLDS

GASKETS

ACCESSORIES



ACCESSORI
CASCADING
FREUD.

CATALOGO 2017/ 2
CATALOGUE 2017/ 2

GOCCIOLATOI
SOGLIE
SOGLIE GUTMANN
GUARNIZIONI
ACCESSORI
WEATHER BARS
THRESHOLDS
GUTMANN THRESHOLDS
GASKETS
ACCESSORIES



ACCESSORI
CASCADING
FREUD.

- 4 GOCCIOLATOI**
WEATHER BARS
- 6** PRG311-010024
8 PRG313-010024
10 PRG317-010024
12 PRG318-010024
14 PRG333-010024
16 PRG334-010024
18 PRG335-010024
20 PRG367-010024
- 22 SOGLIE**
THRESHOLDS
- 24** PRG024-010024
26 PRG025-010024
28 PRG290-010024
30 PRG289-010024
32 PRG028-010024
34 PRG029-010024
36 PRT290-010024
38 PRT289-010024
40 PRT027-010024
42 PRT028-010024
44 PRT028-020024
46 PRT029-010024
48 PRT029-020024
50 PRT038-010024
- 52 ACCESSORI**
ACCESSORIES
- 52** PRG323-010024
. FPA315A010200
53 FPA333A010200
. PRT030-010024
54 PRT031X010024
- 55 PROFILI**
FERMAVETRO
GLASS PROFILES
- 55** PFV1614010024
. PFV2714010024
- 56 SOGLIE GUTMANN**
GUTMANN
THRESHOLDS
- 59** WESER 65 TI
. WESER 75 TI
. WESER 95 TI
. TD 50
. SH Weser
60 WESER 65/20 TI
. WESER 75/20 TI
. WESER 95/20 TI
. WESER 115/20 TI
61 WESER D 8
. WESER D 8 ABS
. WESER TD 8/11
. WESER SH 70
. WESER BS 21.4
. WESER BSP 97.21
62 INT UP 32
. INT P 1668
. INT P 440
. INT P 441
. INT P 60-15
. INT M5x37
63 INT TD 15
. INT TD 20
. INT TD 32
- 64 PROFILO DI CHIUSURA**
PER ALZANTE
SCORREVOLE
LOCKING PROFILE
FOR LIFTING
SLIDING DOORS
- 64** MV 26.11
. HA 3010
. RB 1
. RB 2
. RB 2 MS
- 66 GUARNIZIONI**
GASKETS
- 68** GC-5120040220
. GL-5120010220
. GD-5120030280
. GC-6040030400
. GL-6040010400
69 GC-6100030340
. GL-6100010340
. GD-6100030310
70 GA-1860010220
. GA-2060010220
. GA-9190020215
. GA-8600020200
. GA-9100030450
. GE-5040030400
71 GA-9070020480
. GA-9080020480
. GA-4450010350
72 GC-4110020320
. GD-4110010300
. GC-4140020240
. GC-4150020250
. GD-4150010240
. GA-4180010225
73 GC-4180020200
. GA-5150010225
74 GD-3100020400
. GA-3120020300
. GA-3125020300
. GA-3310020100
. GA-3320020190
75 GE-4300020450
76 GA-8300010300
. GE-8300010250
. GA-8310010340
. GA-8400010300
. GE-8400010250
. GE-8460010250
77 GE-8470010270
. GE-8480010250
. GE-8500010250
78 GE-8300020250
. GA-8310020340
. GA-8400020300
. GE-8470020270
. GE-8500020250
80 GA-3630010300
. GAX8610010322
. GS-6350010200
- 81 ACCESSORI**
ACCESSORIES
- 81** 4104/VR
. 4104/YR
. FP-512A010200

GOCCIOLATOI
WEATHER BARS



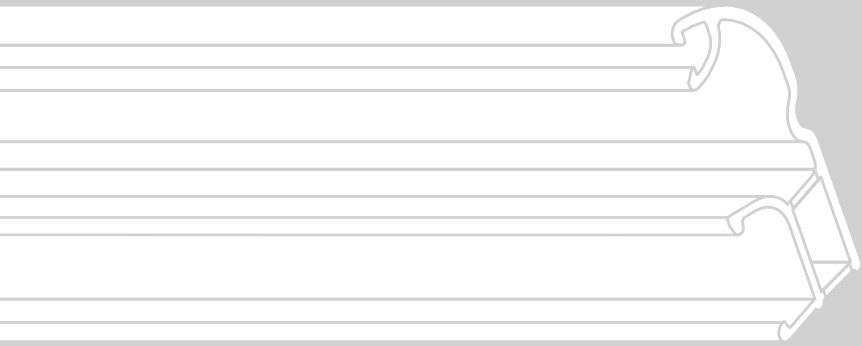

GOCCIOLATOI
WEATHER BARS

ACCESSORI PRG311
ACCESSORIES PRG311

PRG323-010024	GRONDALINO WEATHER BAR SILL		COLORE COLOUR	CF PK
	ALU	PRG323A010024	argento silver	24 ML
	ALU	PRG323B010024	bronzo chiaro light bronze	24 ML
	ALU	PRG323C010024	bronzo scuro dark bronze	24 ML
	ALU	PRG323F010024	bianco white	24 ML
	ALU	PRG323H010024	bronzo medio middle bronze	24 ML

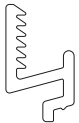
FPA315A010200	CLIP CLIP HOLDER		COLORE COLOUR	CF PK
	ALU	FPA315A010200	grezzo raw	200 PZ

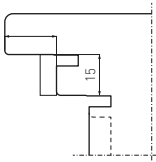
FP-311-010200	TERMINALE END COVER		COLORE COLOUR	CF PK
	TPE	FPB311A010200	bianco white	200 PZ
	TPE	FPN311A010200	marrone brown	200 PZ

PRG313-010024

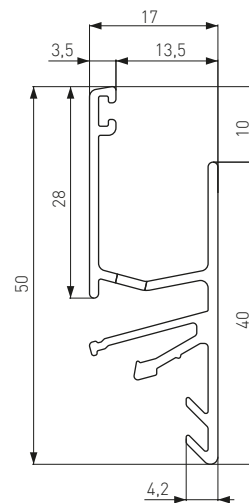
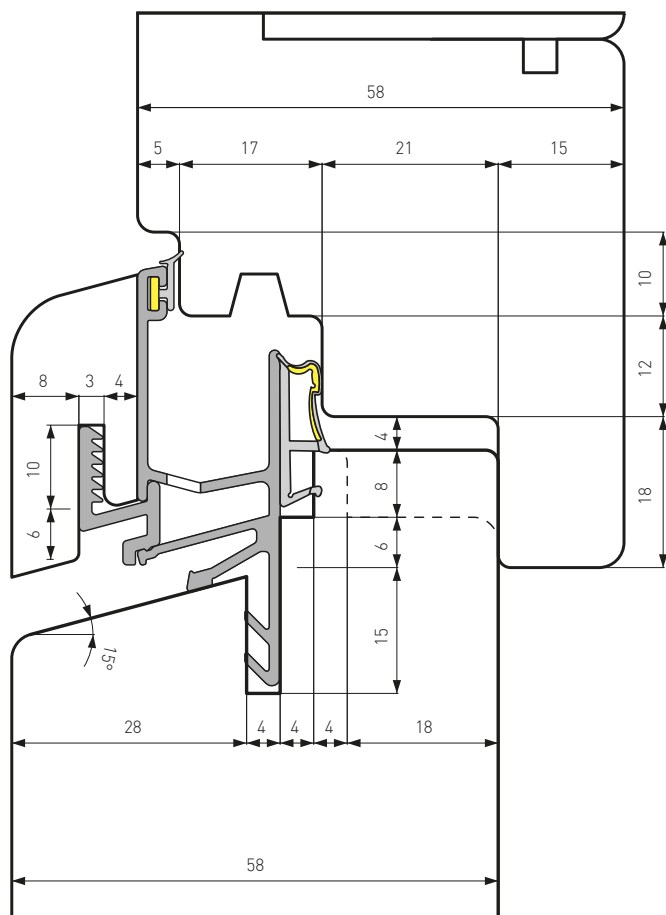

CASCADING FREUD

CE Ermetic 17



ACCESSORI ACCESSORIES

terminale end cover	FP-313A010200	↘ p. 9
clip clip holder	FPA315A010200	↘ p. 54
guarnizione gasket	GA-8600010200	↘ p. 76
	{ GC-5120030220	↘ p. 74
	{ GD-5120020280	↘ p. 74
grondalino weather bar sill	PRG323-010024	↘ p. 54

PRG313-010024	CODICE CODE	COLORE COLOUR	CF PK
	PRG313A010024	argento silver	24 ML
	PRG313B010024	bronzo chiaro light bronze	24 ML
	PRG313C010024	bronzo scuro dark bronze	24 ML
	PRG313F010024	bianco white	24 ML
	PRG313H010024	bronzo medio middle bronze	24 ML

ACCESSORI PRG313
PRG313 ACCESSORIES

PRG323-010024	GRONDALINO WEATHER BAR SILL		COLORE COLOUR	CF PK
	ALU	PRG323A010024	argento silver	24 ML
	ALU	PRG323B010024	bronzo chiaro light bronze	24 ML
	ALU	PRG323C010024	bronzo scuro dark bronze	24 ML
	ALU	PRG323F010024	bianco white	24 ML
	ALU	PRG323H010024	bronzo medio middle bronze	24 ML

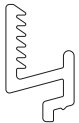
FPA315A010200	CLIP CLIP HOLDER		COLORE COLOUR	CF PK
	ALU	FPA315A010200	grezzo raw	200 PZ

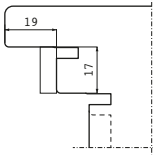
FP-313A010200	TERMINALE END COVER		COLORE COLOUR	CF PK
	TPE	FPB313A010200	bianco white	200 PZ
	TPE	FPN313A010200	marrone brown	200 PZ

GA-8600010200	GUARNIZIONE GASKET		COLORE COLOUR	CF PK
	TP-S	GAB8600010200	bianco white	200 ML
	TP-S	GAM8600010200	marrone brown	200 ML
	TP-S	GAN8600010200	nero black	200 ML

PRG317-010024

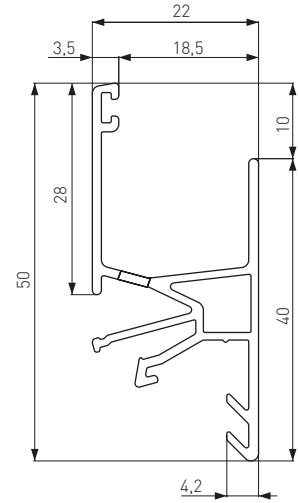
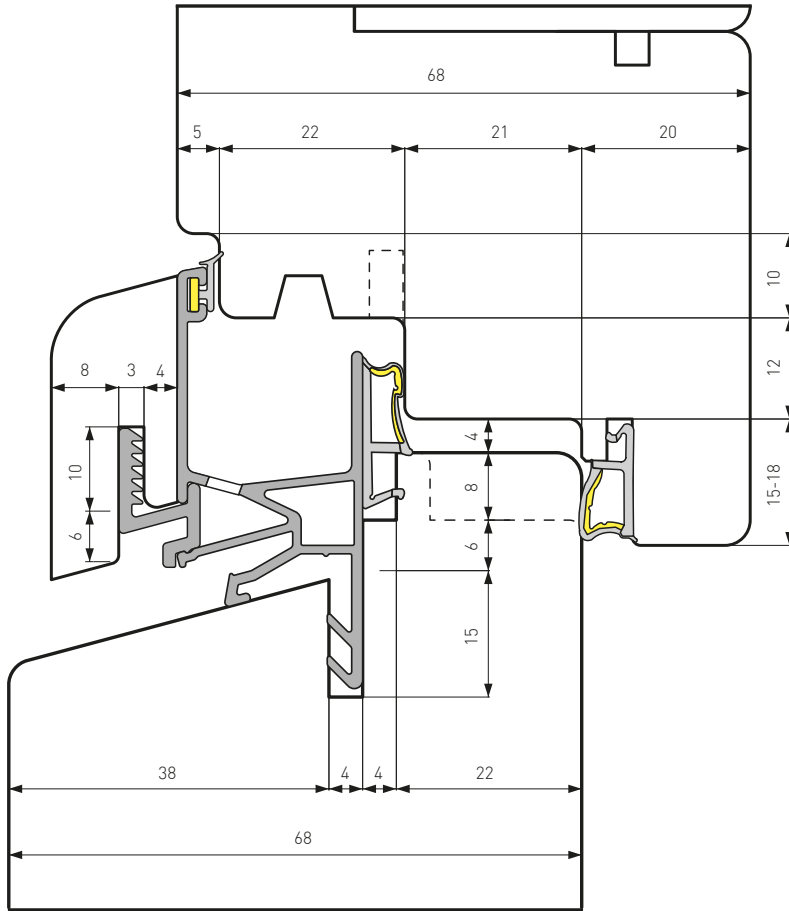

CASCADING FREUD

CE Euronorm



ACCESSORI ACCESSORIES

terminale end cover	FP-317A010200	➤ p. 11
clip clip holder	FPA315A010200	➤ p. 54
guarnizione gasket	GA-8600010200	➤ p. 76
	{ GC-5120030220	➤ p. 74
	{ GD-5120020280	➤ p. 74
	{ GC-6100020340	➤ p. 74
	{ GD-6100010310	➤ p. 74
grondalino weather bar sill	PRG323-010024	➤ p. 54

PRG317-010024	CODICE CODE	COLORE COLOUR	CF PK
	PRG317A010024	argento silver	24 ML
	PRG317B010024	bronzo chiaro light bronze	24 ML
	PRG317C010024	bronzo scuro dark bronze	24 ML
	PRG317F010024	bianco white	24 ML
	PRG317H010024	bronzo medio middle bronze	24 ML

ACCESSORI PRG317
PRG317 ACCESSORIES

PRG323-010024	GRONDALINO WEATHER BAR SILL		COLORE COLOUR	CF PK
	ALU	PRG323A010024	argento silver	24 ML
	ALU	PRG323B010024	bronzo chiaro light bronze	24 ML
	ALU	PRG323C010024	bronzo scuro dark bronze	24 ML
	ALU	PRG323F010024	bianco white	24 ML
	ALU	PRG323H010024	bronzo medio middle bronze	24 ML

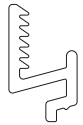
FPA315A010200	CLIP CLIP HOLDER		COLORE COLOUR	CF PK
	ALU	FPA315A010200	grezzo raw	200 PZ

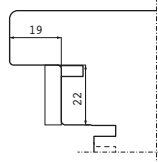
FP-317A010200	TERMINALE END COVER		COLORE COLOUR	CF PK
	TPE	FPB317A010200	bianco white	200 PZ
	TPE	FPN317A010200	marrone brown	200 PZ

GA-8600010200	GUARNIZIONE GASKET		COLORE COLOUR	CF PK
	TP-S	GAB8600010200	bianco white	200 ML
	TP-S	GAM8600010200	marrone brown	200 ML
	TP-S	GAN8600010200	nero black	200 ML

PRG318-010024

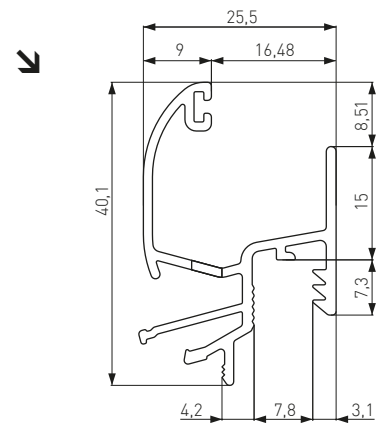
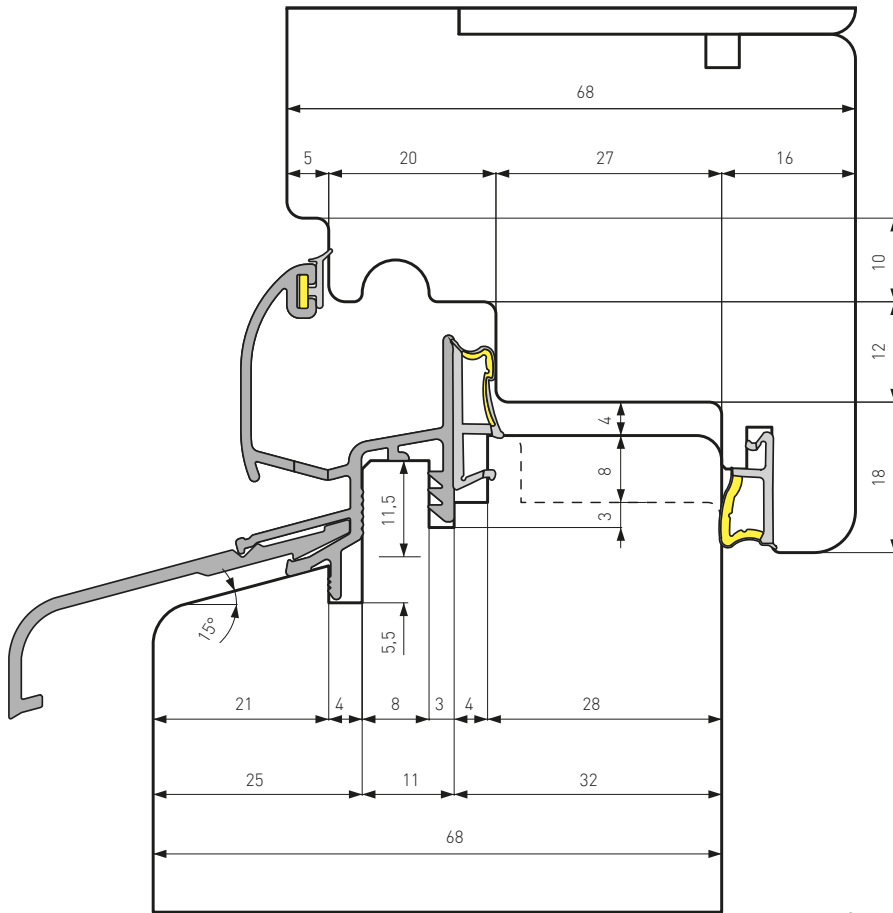

CASCADING FREUD

CE Euronorm C-13



ACCESSORI ACCESSORIES

terminale end cover	FP-318A010200	↘ p. 13
guarnizione gasket	GA-8600010200	↘ p. 76
{	GC-5120030220	↘ p. 74
{	GD-5120020280	↘ p. 74
{	GC-6100020340	↘ p. 74
{	GD-6100010310	↘ p. 74
grondalino weather bar sill	PRG323-010024	↘ p. 54

PRG318-010024	CODICE CODE	COLORE COLOUR	CF PK
	PRG318A010024	argento silver	24 ML
	PRG318B010024	bronzo chiaro light bronze	24 ML
	PRG318C010024	bronzo scuro dark bronze	24 ML
	PRG318F010024	bianco white	24 ML
	PRG318H010024	bronzo medio middle bronze	24 ML

ACCESSORI PRG318
PRG318 ACCESSORIES

PRG323-010024	GRONDALINO WEATHER BAR SILL		COLORE COLOUR	CF PK
	ALU	PRG323A010024	argento silver	24 ML
	ALU	PRG323B010024	bronzo chiaro light bronze	24 ML
	ALU	PRG323C010024	bronzo scuro dark bronze	24 ML
	ALU	PRG323F010024	bianco white	24 ML
	ALU	PRG323H010024	bronzo medio middle bronze	24 ML

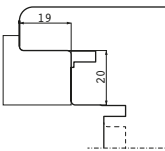
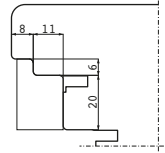
FP-318A010200	TERMINALE END COVER		COLORE COLOUR	CF PK
	TPE	FPB318A010200	bianco white	200 PZ
	TPE	FPN318A010200	marrone brown	200 PZ
	TPE	FPB318B010200	bianco white	200 PZ
	TPE	FPN318B010200	marrone brown	200 PZ

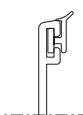
GA-8600010200	GUARNIZIONE GASKET		COLORE COLOUR	CF PK
	TP-S	GAB8600010200	bianco white	200 ML
	TP-S	GAM8600010200	marrone brown	200 ML
	TP-S	GAN8600010200	nero black	200 ML

PRG333-010024

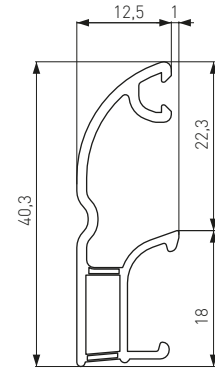
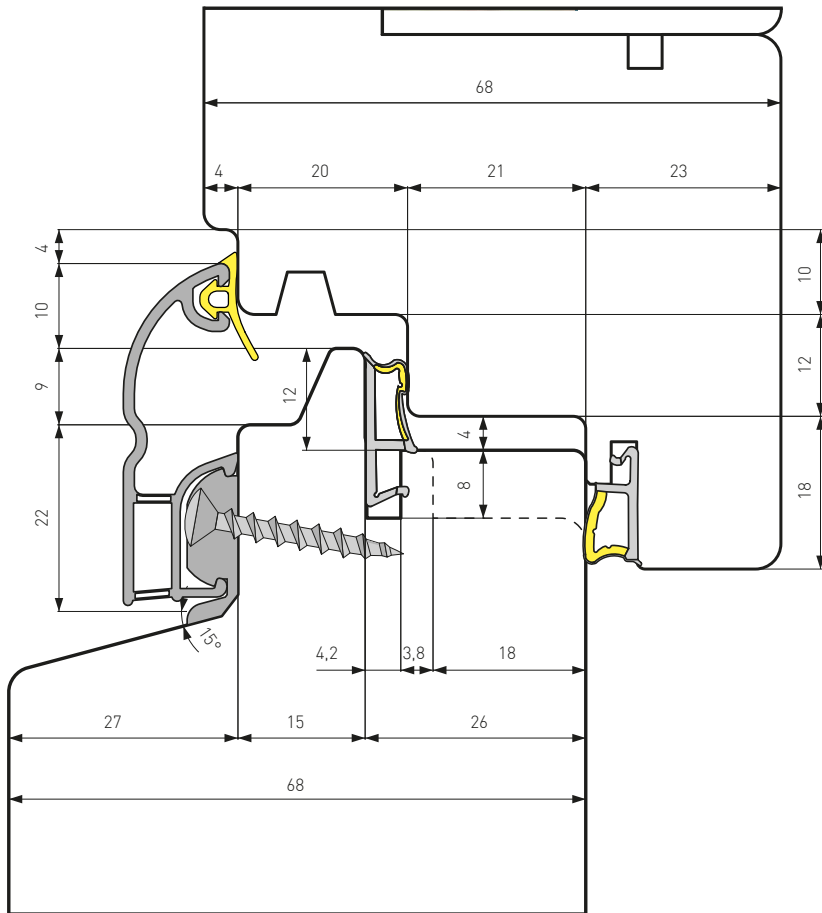

CASCADING FREUD

- CE Euronorm C-13
- CE Eurost
- CE Eurost 17
- CE Fox 92
- CE Freumex
- CE Freumex 17
- CE Freumex C-13
- CE Ghost



ACCESSORI ACCESSORIES

- terminale end cover | FP-333-010200 | p. 15
- clip clip holder | FPA333A010200 | p. 54
- guarnizione gasket | GA-9100020450 | p. 76
- { GC-5120030220 | p. 74
- { GD-5120020280 | p. 74
- { GC-6100020340 | p. 74
- { GD-6100010310 | p. 74

PRG333-010024	CODICE CODE	COLORE COLOUR	CF PK
	PRG333A010024	argento silver	24 ML
	PRG333B010024	bronzo chiaro light bronze	24 ML
	PRG333C010024	bronzo scuro dark bronze	24 ML
	PRG333F010024	bianco white	24 ML
	PRG333H010024	bronzo medio middle bronze	24 ML

ACCESSORI PRG333
PRG333 ACCESSORIES

FPA333A010024		CLIP CLIP HOLDER	COLORE COLOUR	CF PK
	NYLON	FPA333A010200	neutro neutral	200 PZ

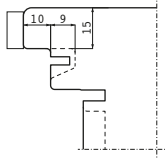
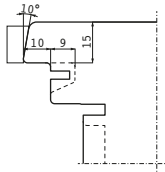
FP-333-010200		TERMINALE END COVER	COLORE COLOUR	CF PK
* 	TPE	FPB333A010200	bianco white	200 PZ
	TPE	FPN333A010200	marrone brown	200 PZ
	* diritto right			
** 	TPE	FPB333B010200	bianco white	200 PZ
	TPE	FPN333B010200	marrone brown	200 PZ
	** inclinato inclined			
*** 	TPE	FPB333C010200	bianco white	200 PZ
	TPE	FPN333C010200	marrone brown	200 PZ
	*** morbido soft			
**** 	TPE	FPB333D010200	bianco white	200 PZ
	TPE	FPN333D010200	marrone brown	200 PZ
	**** compensazione compensation			

GA-9100020450		GUARNIZIONE GASKET	COLORE COLOUR	CF PK
	TP-S	GAB9100020450	bianco white	450 ML
	TP-S	GAG9100020450	grigio grey	450 ML
	TP-S	GAM9100020450	marrone brown	450 ML
	TP-S	GAN9100020450	nero black	450 ML

PRG334-010024

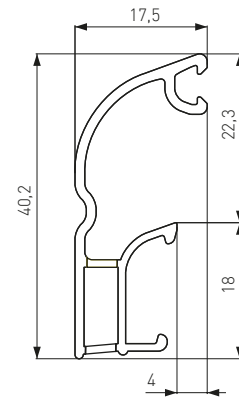
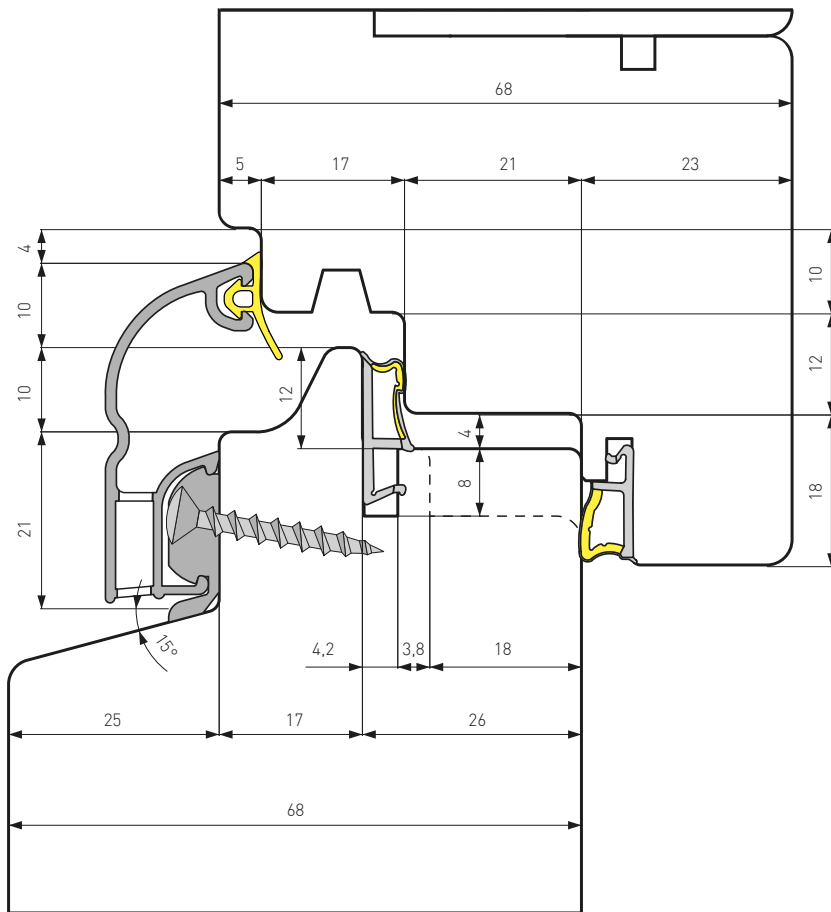

CASCADING FREUD

Ermetic 17
 Euronorm



ACCESSORI ACCESSORIES

terminale end cover	FP-334-010200	↘ p. 17
clip clip holder	FPA333A010200	↘ p. 54
guarnizione gasket	GA-9100020450	↘ p. 76
	{ GC-5120030220	↘ p. 74
	{ GD-5120020280	↘ p. 74
	{ GC-6100020340	↘ p. 74
	{ GD-6100010310	↘ p. 74

PRG334-010024	CODICE CODE	COLORE COLOUR	CF PK
	PRG334A010024	argento silver	24 ML
	PRG334B010024	bronzo chiaro light bronze	24 ML
	PRG334C010024	bronzo scuro dark bronze	24 ML
	PRG334F010024	bianco white	24 ML
	PRG334H010024	bronzo medio middle bronze	24 ML

ACCESSORI PRG334
PRG334 ACCESSORIES

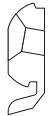
FPA333A010024		CLIP CLIP HOLDER	COLORE COLOUR	CF PK
	NYLON	FPA333A010200	neutro neutral	200 PZ

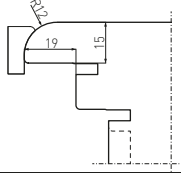
FP-334-010200		TERMINALE END COVER	COLORE COLOUR	CF PK
* 	TPE	FPB334A010200	bianco white	200 PZ
	TPE	FPN334A010200	marrone brown	200 PZ
	* diritto right			
** 	TPE	FPB334B010200	bianco white	200 PZ
	TPE	FPN334B010200	marrone brown	200 PZ
	** inclinato inclined			
*** 	TPE	FPB334C010200	bianco white	200 PZ
	TPE	FPN334C010200	marrone brown	200 PZ
	*** morbido soft			

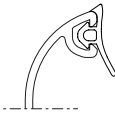
GA-9100020450		GUARNIZIONE GASKET	COLORE COLOUR	CF PK
	TP-S	GAB9100020450	bianco white	450 ML
	TP-S	GAG9100020450	grigio grey	450 ML
	TP-S	GAM9100020450	marrone brown	450 ML
	TP-S	GAN9100020450	nero black	450 ML

PRG335-010024

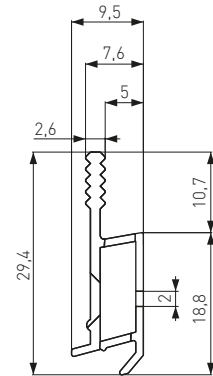
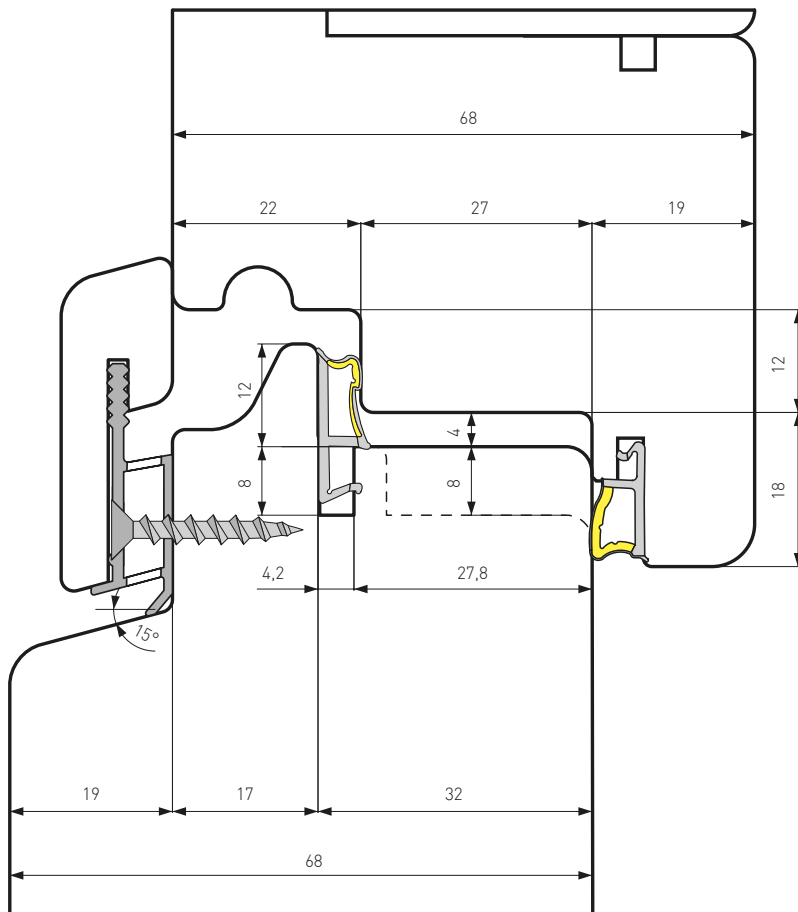

CASCADING FREUD

- CE Euronorm C-13
- CE Fox 92
- CE Freumex
- CE Freumex 17
- CE Freumex C-13



ACCESSORI ACCESSORIES

- | | | |
|--------------------|---------------|---------|
| guarnizione gasket | GC-5120030220 | ➤ p. 74 |
| { | GD-5120020280 | ➤ p. 74 |
| { | GC-6100020340 | ➤ p. 74 |
| { | GD-6100010310 | ➤ p. 74 |

PRG335-010024	CODICE CODE	COLORE COLOUR	CF PK
	PRG335A010024	argento silver	24 ML
	PRG335B010024 *	bronzo chiaro light bronze	24 ML
	PRG335C010024 *	bronzo scuro dark bronze	24 ML
	PRG335F010024 *	bianco white	24 ML
	PRG335H010024 *	bronzo medio middle bronze	24 ML

*** FINO A ESAURIMENTO SCORTE**
WHILE SUPPLIES LAST

ACCESSORI PRG334
PRG334 ACCESSORIES

GA-9100020450		GUARNIZIONE GASKET	COLORE COLOUR	CF PK
	TP-S	GAB9100020450	bianco white	450 ML
	TP-S	GAG9100020450	grigio grey	450 ML
	TP-S	GAM9100020450	marrone brown	450 ML
	TP-S	GAN9100020450	nero black	450 ML

PRG367-010024

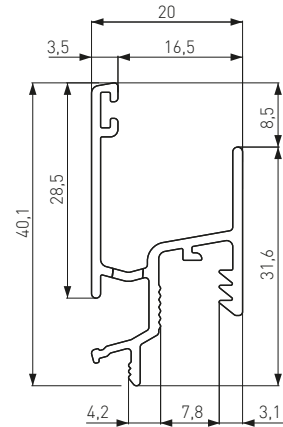
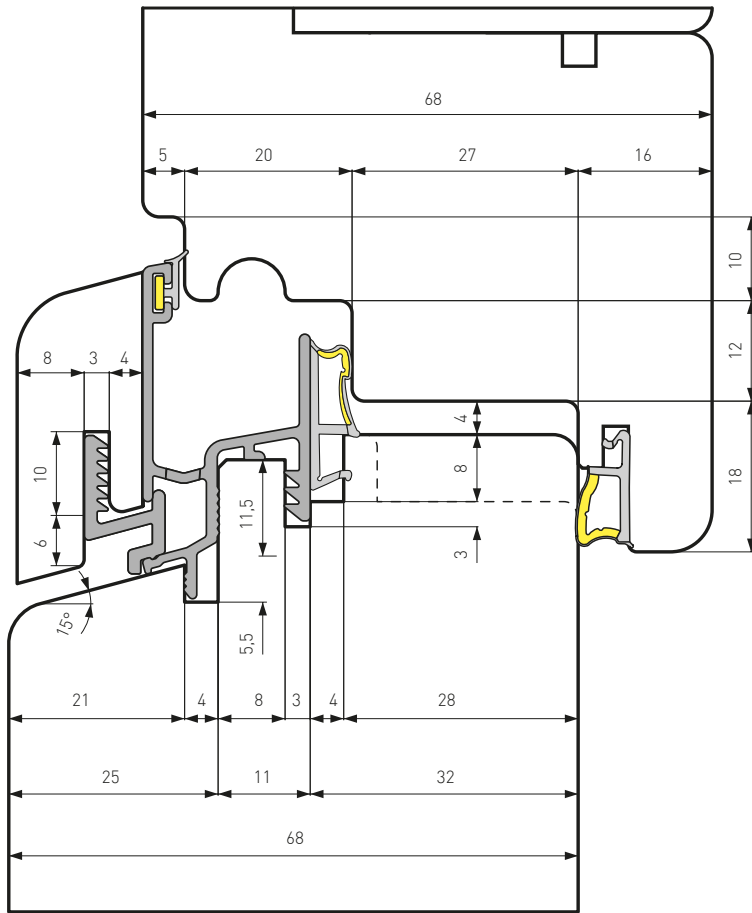

CASCADING FREUD

CE Euronorm C-13



ACCESSORI ACCESSORIES

terminale end cover	FP-367-010200	➤ p. 21
clip clip holder	FPA315A010200	➤ p. 54
guarnizione gasket	GA-8600010200	➤ p. 76
	{ GC-5120030220	➤ p. 74
	{ GD-5120020280	➤ p. 74
	{ GC-6100020340	➤ p. 74
	{ GD-6100010310	➤ p. 74

PRG367-010024	CODICE CODE	COLORE COLOUR	CF PK
	PRG367A010024	argento silver	24 ML
	PRG367B010024	bronzo chiaro light bronze	24 ML
	PRG367C010024	bronzo scuro dark bronze	24 ML
	PRG367F010024	bianco white	24 ML
	PRG367H010024	bronzo medio middle bronze	24 ML

ACCESSORI PRG367
PRG367 ACCESSORIES

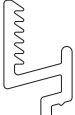
FPA315A010200	CLIP CLIP HOLDER		COLORE COLOUR	CF PK
	ALU	FPA315A010200	grezzo raw	200 PZ

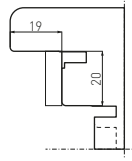
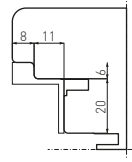
FP-367-010200	TERMINALE END COVER		COLORE COLOUR	CF PK
* 	TPE	FPB367A010200	bianco white	200 PZ
	TPE	FPN367A010200	marrone brown	200 PZ
* spessore 68 mm thickness 68 mm				
** 	TPE	FPB367B010200	bianco white	200 PZ
	TPE	FPN367B010200	marrone brown	200 PZ
** spessore 78 mm thickness 78 mm				

GA-8600010200	GUARNIZIONE GASKET		COLORE COLOUR	CF PK
	TP-S	GAB8600010200	bianco white	200 ML
	TP-S	GAM8600010200	marrone brown	200 ML
	TP-S	GAN8600010200	nero black	200 ML

SOGLIE
THRESHOLDS



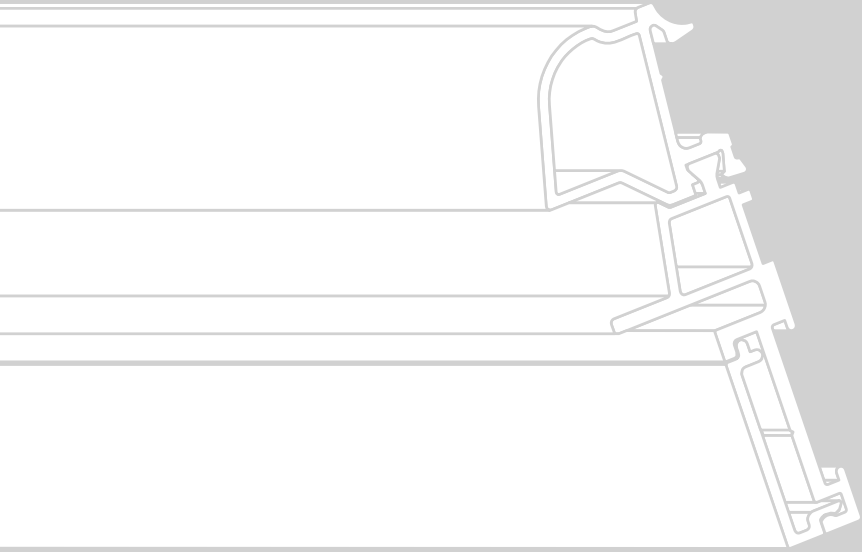

PRG024-010024

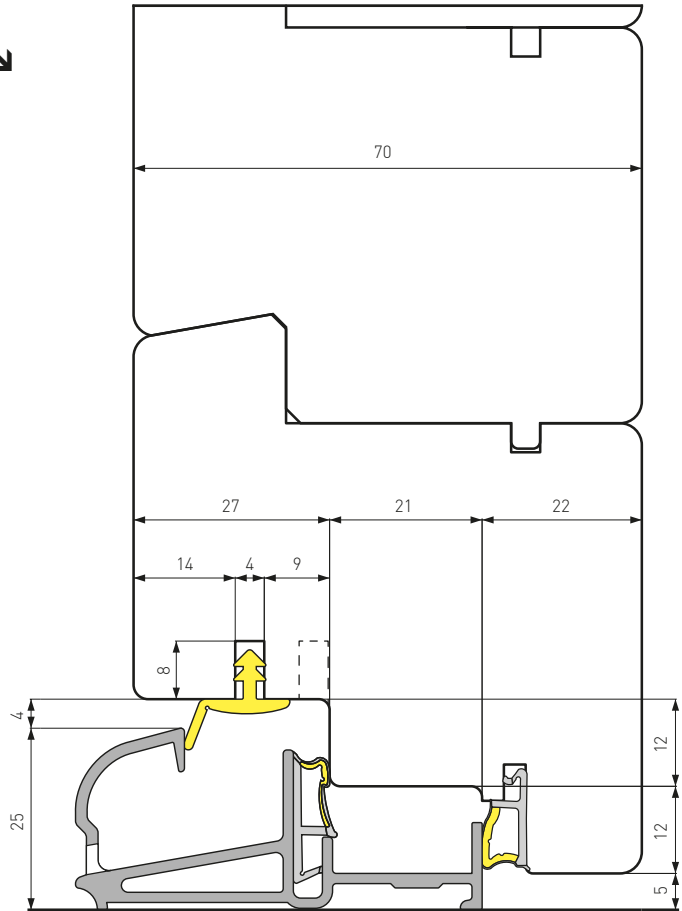
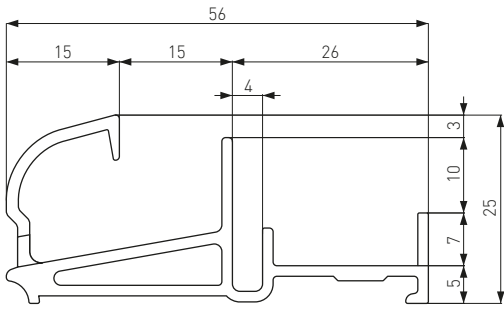

CASCADING FREUD

- CE Ermetic
- CE Ermetic 17
- CE Euronorm
- CE Eurost
- CE Eurost 17
- CE Freumex
- CE Freumex 17



ACCESSORI ACCESSORIES

- terminale end cover FPN024A010200 p. 27
- guarnizione gasket GA-9190010215 p. 76
- { GC-5120030220 p. 74
- { GD-5120020280 p. 74
- { GC-6100020340 p. 74
- { GD-6100010310 p. 74

PRG024-010024	CODICE CODE	COLORE COLOUR	CF PK
	PRG024A010024	argento silver	24 ML
	PRG024B010024	bronzo chiaro light bronze	24 ML
	PRG024C010024	bronzo scuro dark bronze	24 ML
	PRG024F010024	bianco white	24 ML
	PRG024H010024	bronzo medio middle bronze	24 ML

ACCESSORI PRG024
PRG024 ACCESSORIES

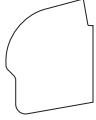
FPN024A010200		TERMINALE END COVER	COLORE COLOUR	CF PK
	TPP	FPN024A010200	neutro neutral	200 PZ

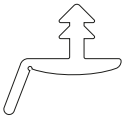
GA-9190010215		GUARNIZIONE GASKET	COLORE COLOUR	CF PK
	TP-S	GAB9190010215	bianco white	215 ML
	TP-S	GAM9190010215	marrone brown	215 ML
	TP-S	GAN9190010215	nero black	215 ML

PRG025-010024

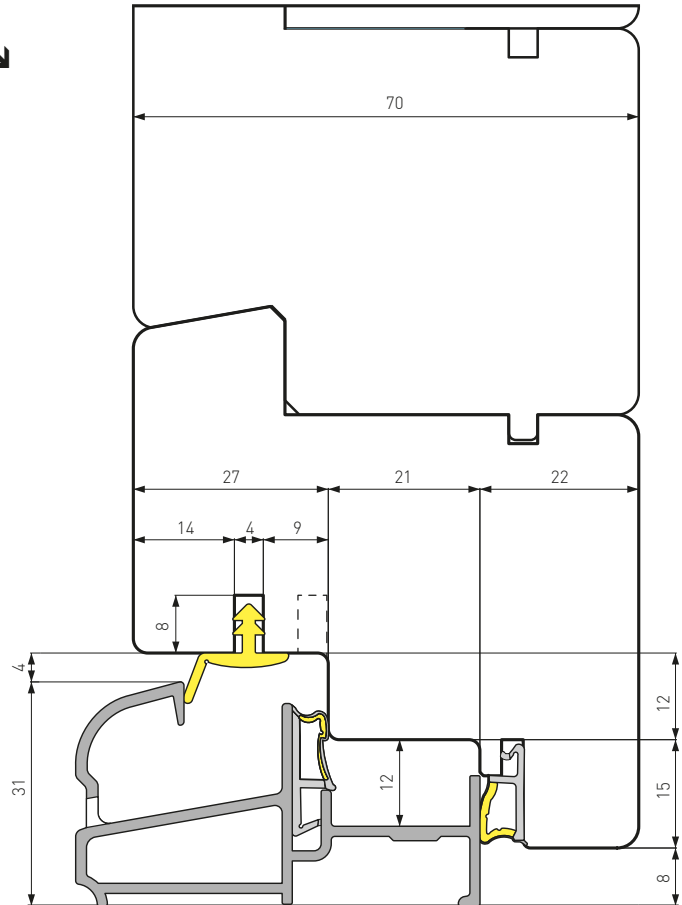
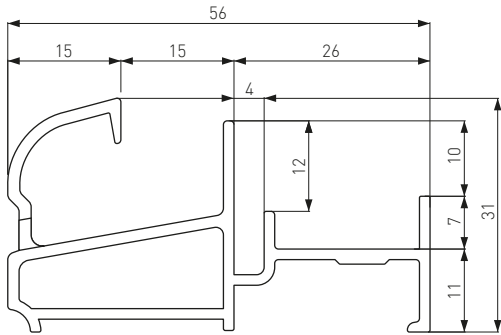

CASCADING FREUD

- ☒ Ermetic
- ☒ Ermetic 17
- ☒ Euronorm
- ☒ Eurost
- ☒ Eurost 17
- ☒ Freumex
- ☒ Freumex 17



ACCESSORI ACCESSORIES

- terminale end cover | FPN025A010200 ↘ p. 29
- guarnizione gasket | GA-9190010215 ↘ p. 76
- { GC-5120030220 ↘ p. 74
- { GD-5120020280 ↘ p. 74
- { GC-6100020340 ↘ p. 74
- { GD-6100010310 ↘ p. 74

PRG025-010024	CODICE CODE	COLORE COLOUR	CF PK
	PRG025A010024	argento silver	24 ML
	PRG025B010024	bronzo chiaro light bronze	24 ML
	PRG025C010024	bronzo scuro dark bronze	24 ML
	PRG025F010024	bianco white	24 ML
	PRG025H010024	bronzo medio middle bronze	24 ML

ACCESSORI PRG025
PRG025 ACCESSORIES

FPN025A010200		TERMINALE END COVER	COLORE COLOUR	CF PK
	TPP	FPN025A010200	neutro neutral	200 PZ

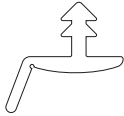
GA-9190010215		GUARNIZIONE GASKET	COLORE COLOUR	CF PK
	TP-S	GAB9190010215	bianco white	215 ML
	TP-S	GAM9190010215	marrone brown	215 ML
	TP-S	GAN9190010215	nero black	215 ML

PRG290-010024

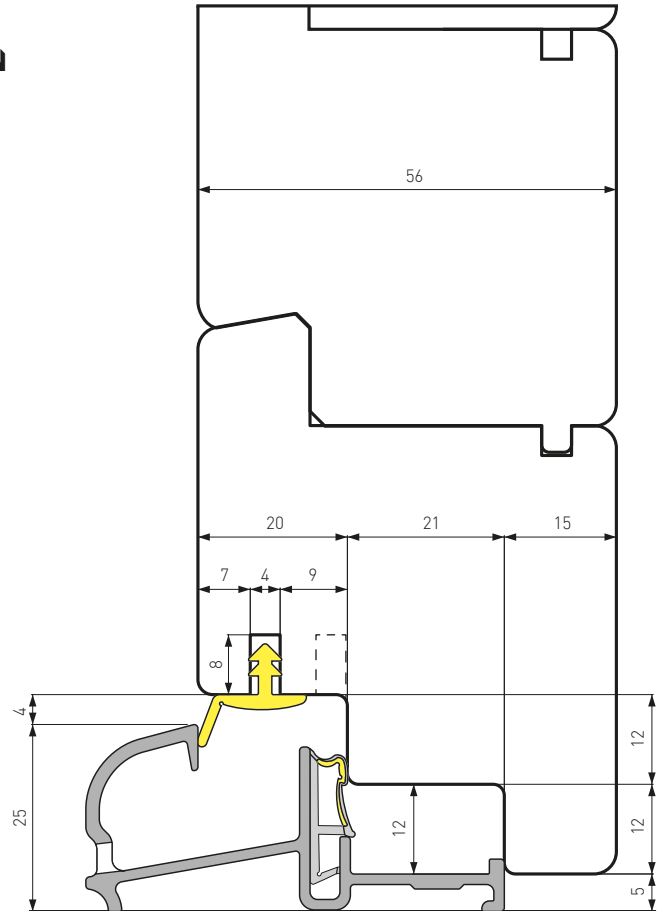
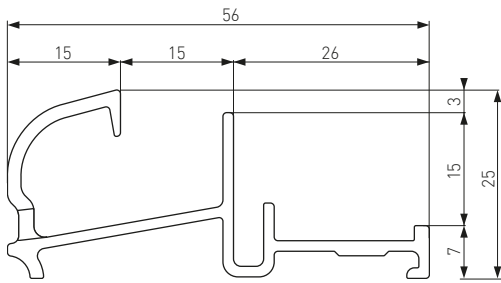

CASCADING FREUD

- CE Ermetic
- CE Ermetic 17
- CE Euronorm
- CE Eurost
- CE Eurost 17
- CE Freumex
- CE Freumex 17



ACCESSORI ACCESSORIES

- terminale end cover | FPN289A010200 ↘ p. 31
- guarnizione gasket | GA-9190010215 ↘ p. 76
- { GC-5120030220 ↘ p. 74
- { GD-5120020280 ↘ p. 74

PRG290-010024	CODICE CODE	COLORE COLOUR	CF PK
	PRG290A010024	argento silver	24 ML
	PRG290B010024	bronzo chiaro light bronze	24 ML
	PRG290C010024	bronzo scuro dark bronze	24 ML
	PRG290F010024	bianco white	24 ML
	PRG290H010024	bronzo medio middle bronze	24 ML

ACCESSORI PRG290
PRG290 ACCESSORIES

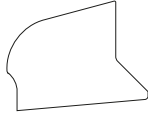
FPN289A010200		TERMINALE END COVER	COLORE COLOUR	CF PK
	TPP	FPN289A010200	neutro neutral	200 PZ

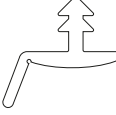
GA-9190010215		GUARNIZIONE GASKET	COLORE COLOUR	CF PK
	TP-S	GAB9190010215	bianco white	215 ML
	TP-S	GAM9190010215	marrone brown	215 ML
	TP-S	GAN9190010215	nero black	215 ML

PRG289-010024

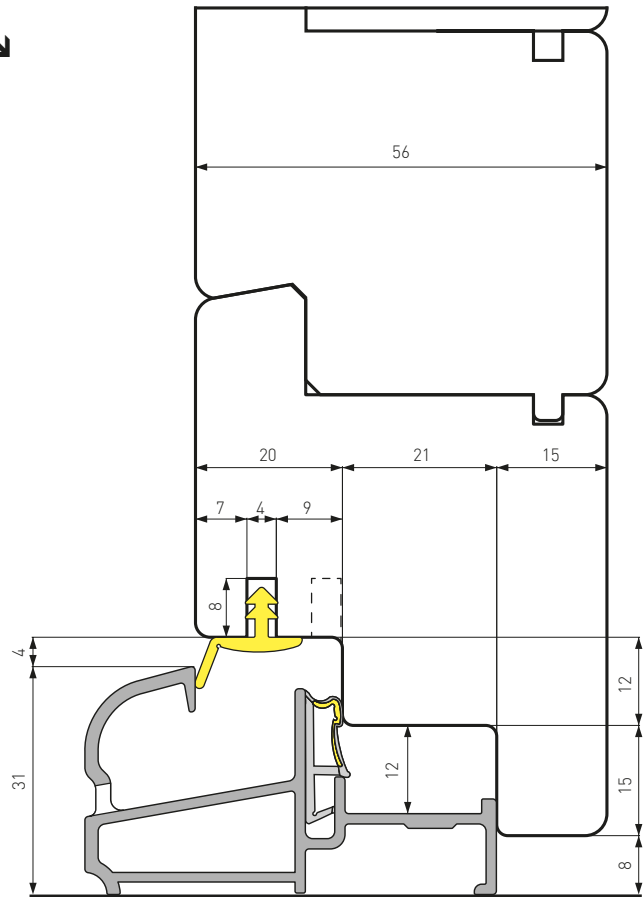
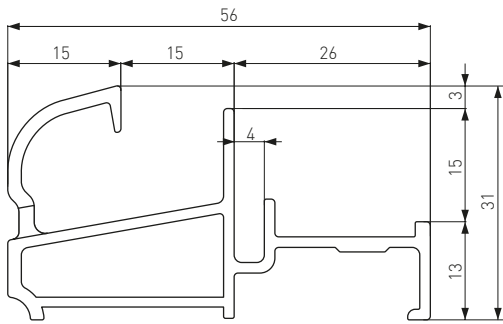

CASCADING FREUD

- CE 100 Ermetic
- CE 100 Ermetic 17
- CE 100 Euronorm
- CE 100 Eurost
- CE 100 Eurost 17
- CE 100 Freumex
- CE 100 Freumex 17



ACCESSORI ACCESSORIES

- terminale end cover FPN289A010200 ↘ p. 33
- guarnizione gasket GA-9190010215 ↘ p. 76
- { GC-5120030220 ↘ p. 74
- { GD-5120020280 ↘ p. 74

PRG289-010024	CODICE CODE	COLORE COLOUR	CF PK
	PRG289A010024	argento silver	24 ML
	PRG289B010024	bronzo chiaro light bronze	24 ML
	PRG289C010024	bronzo scuro dark bronze	24 ML
	PRG289F010024	bianco white	24 ML
	PRG289H010024	bronzo medio middle bronze	24 ML

ACCESSORI PRG289
PRG289 ACCESSORIES

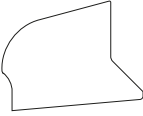
FPN289A010200		TERMINALE END COVER	COLORE COLOUR	CF PK
	TPP	FPN289A010200	neutro neutral	200 PZ

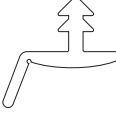
GA-9190010215		GUARNIZIONE GASKET	COLORE COLOUR	CF PK
	TP-S	GAB9190010215	bianco white	215 ML
	TP-S	GAM9190010215	marrone brown	215 ML
	TP-S	GAN9190010215	nero black	215 ML

PRG028-010024

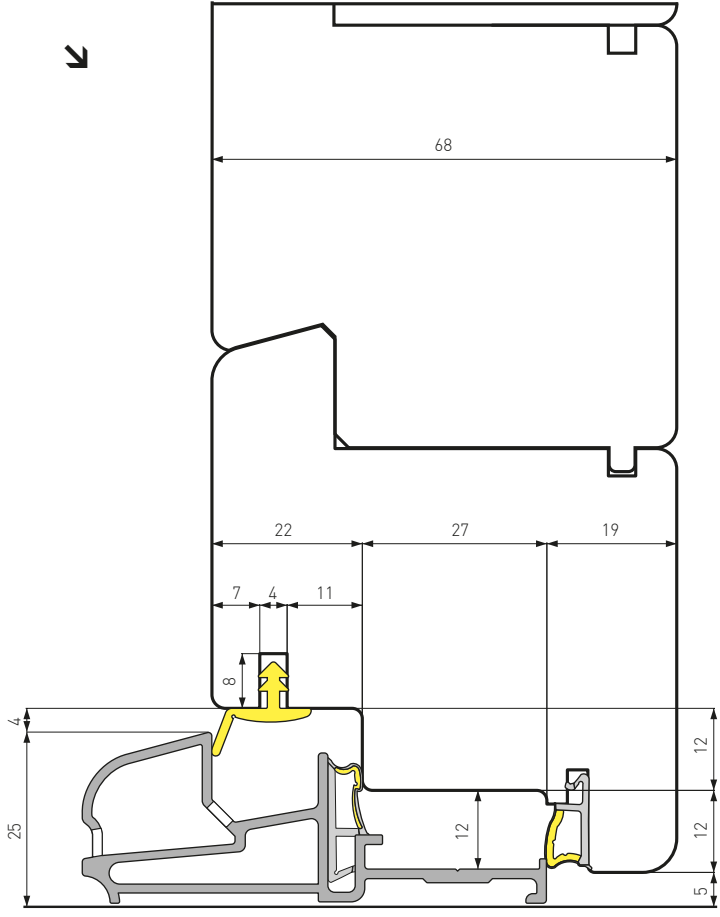
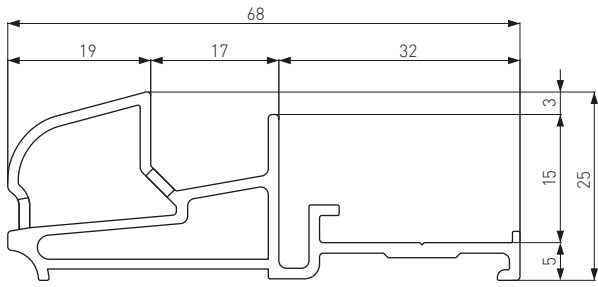

CASCADING FREUD

- CE 100 Euronorm C-13
- CE 100 Fox 92
- CE 100 Freumex C-13
- CE 100 Ghost
- CE 100 Luce



ACCESSORI ACCESSORIES

- terminale end cover FPN028A010200 ↘ p. 35
- guarnizione gasket GA-9190010215 ↘ p. 76
- { GC-5120030220 ↘ p. 74
- { GD-5120020280 ↘ p. 74
- { GC-6100020340 ↘ p. 74
- { GD-6100010310 ↘ p. 74

PRG028-010024	CODICE CODE	COLORE COLOUR	CF PK
	PRG028A010024	argento silver	24 ML
	PRG028B010024	bronzo chiaro light bronze	24 ML
	PRG028C010024	bronzo scuro dark bronze	24 ML
	PRG028F010024	bianco white	24 ML
	PRG028H010024	bronzo medio middle bronze	24 ML

ACCESSORI PRG289
PRG289 ACCESSORIES

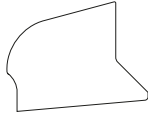
FPN028A010200		TERMINALE END COVER	COLORE COLOUR	CF PK
	TPP	FPN028A010200	neutro neutral	200 PZ

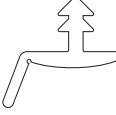
GA-9190010215		GUARNIZIONE GASKET	COLORE COLOUR	CF PK
	TP-S	GAB9190010215	bianco white	215 ML
	TP-S	GAM9190010215	marrone brown	215 ML
	TP-S	GAN9190010215	nero black	215 ML

PRG029-010024

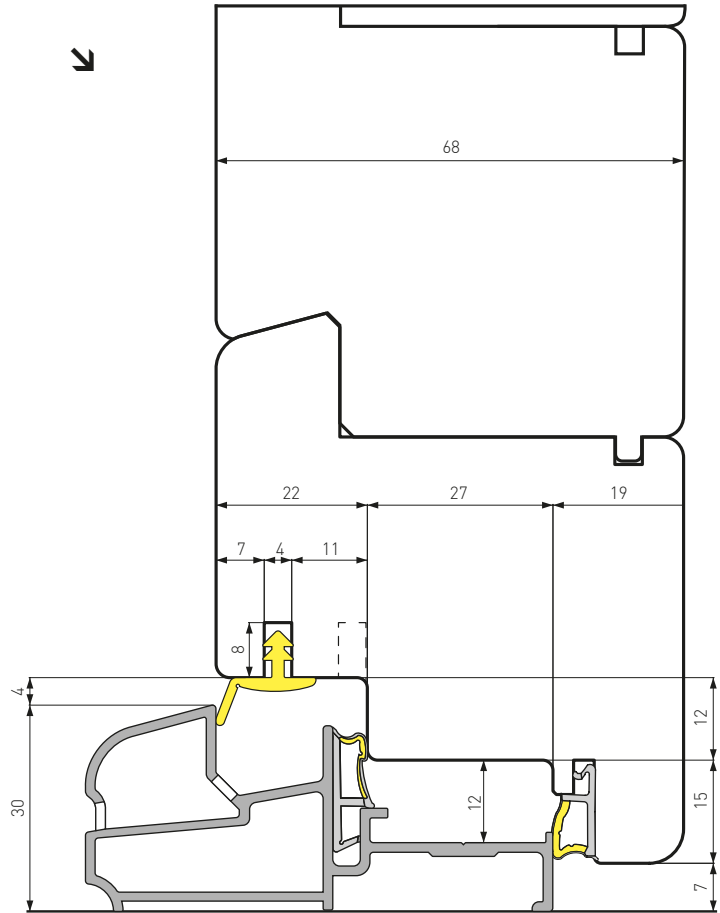
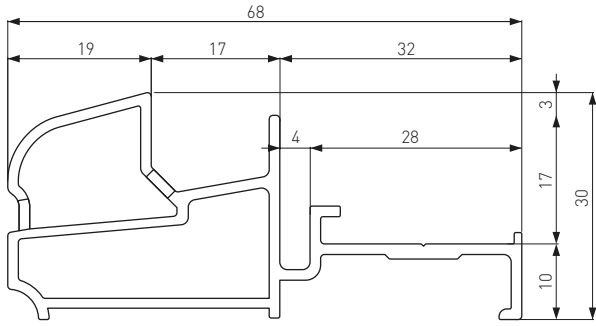

CASCADING FREUD

- CE 100 Euronorm C-13
- CE 100 Fox 92
- CE 100 Freumex C-13
- CE 100 Ghost
- CE 100 Luce



ACCESSORI ACCESSORIES

- terminale end cover FPN028A010200 ↘ p. 37
- guarnizione gasket GA-9190010215 ↘ p. 76
- { GC-5120030220 ↘ p. 74
- { GD-5120020280 ↘ p. 74
- { GC-6100020340 ↘ p. 74
- { GD-6100010310 ↘ p. 74

PRG029-010024	CODICE CODE	COLORE COLOUR	CF PK
	PRG029A010024	argento silver	24 ML
	PRG029B010024	bronzo chiaro light bronze	24 ML
	PRG029C010024	bronzo scuro dark bronze	24 ML
	PRG029F010024	bianco white	24 ML
	PRG029H010024	bronzo medio middle bronze	24 ML

ACCESSORI PRG029
PRG029 ACCESSORIES

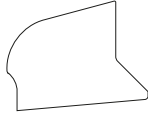
FPN028A010200		TERMINALE END COVER	COLORE COLOUR	CF PK
	TPP	FPN028A010200	neutro neutral	200 PZ

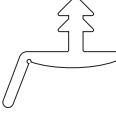
GA-9190010215		GUARNIZIONE GASKET	COLORE COLOUR	CF PK
	TP-S	GAB9190010215	bianco white	215 ML
	TP-S	GAM9190010215	marrone brown	215 ML
	TP-S	GAN9190010215	nero black	215 ML

PRT290-010024
SOGLIA A TAGLIO TERMICO
 THERMAL CUT THRESHOLD

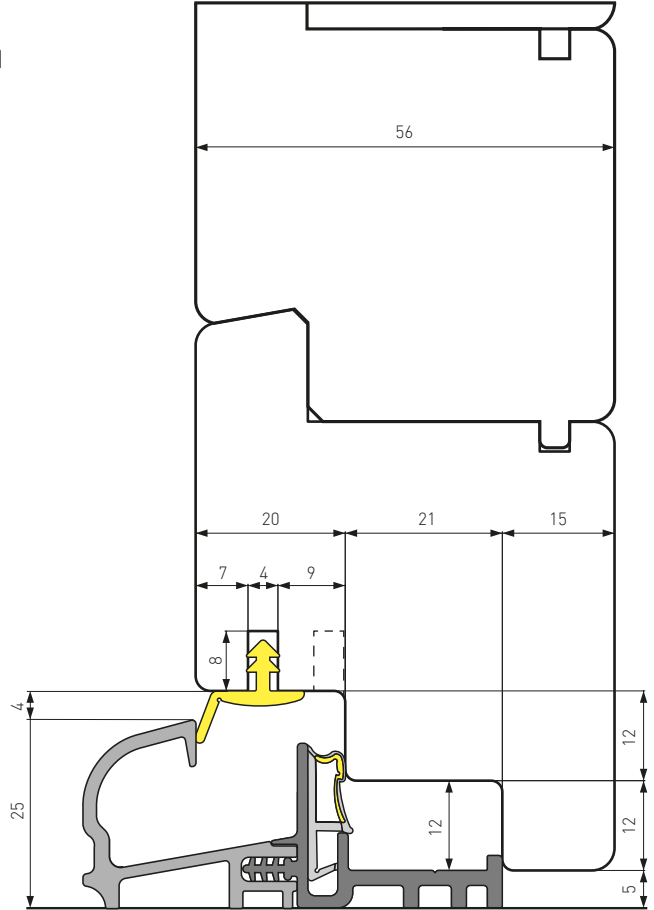
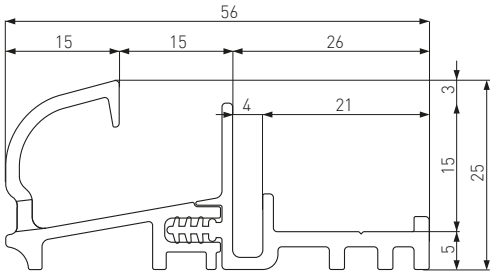

CASCADING FREUD

- CE Ermetic
- CE Ermetic 17
- CE Euronorm
- CE Eurost
- CE Eurost 17
- CE Freumex
- CE Freumex 17



ACCESSORI ACCESSORIES

- terminale end cover | FPN289A010200 ↘ p. 39
- guarnizione gasket | GA-9190010215 ↘ p. 76
- { GC-5120030220 ↘ p. 74
- { GD-5120020280 ↘ p. 74

PRT290-010024	CODICE CODE	COLORE COLOUR	CF PK
	PRT290A010024	argento silver	24 ML
	PRT290B010024	bronzo chiaro light bronze	24 ML
	PRT290C010024	bronzo scuro dark bronze	24 ML
	PRT290F010024	bianco white	24 ML
	PRT290H010024	bronzo medio middle bronze	24 ML

ACCESSORI PRT290
PRT290 ACCESSORIES

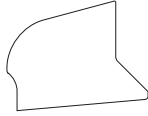
FPN289A010200		TERMINALE END COVER	COLORE COLOUR	CF PK
	TPP	FPN289A010200	neutro neutral	200 PZ

GA-9190010215		GUARNIZIONE GASKET	COLORE COLOUR	CF PK
	TP-S	GAB9190010215	bianco white	215 ML
	TP-S	GAM9190010215	marrone brown	215 ML
	TP-S	GAN9190010215	nero black	215 ML

PRT289-010024
SOGLIA A TAGLIO TERMICO
 THERMAL CUT THRESHOLD

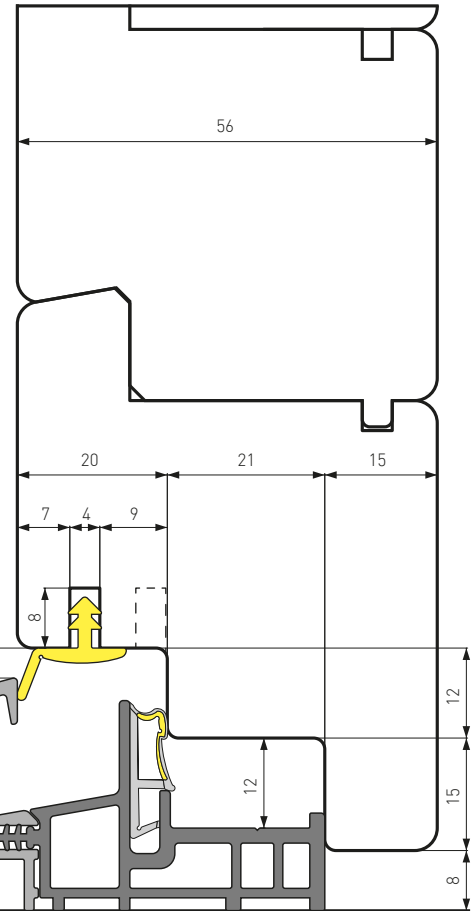
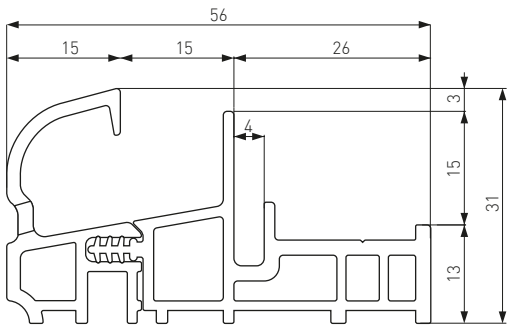

CASCADING FREUD

- CE Ermetic
- CE Ermetic 17
- CE Euronorm
- CE Eurost
- CE Eurost 17
- CE Freumex
- CE Freumex 17



ACCESSORI ACCESSORIES

- terminale end cover FPN289A010200 ↘ p. 41
- guarnizione gasket GA-9190010215 ↘ p. 76
- { GC-5120030220 ↘ p. 74
- { GD-5120020280 ↘ p. 74

PRT289-010024	CODICE CODE	COLORE COLOUR	CF PK
	PRT289A010024	argento silver	24 ML
	PRT289B010024	bronzo chiaro light bronze	24 ML
	PRT289C010024	bronzo scuro dark bronze	24 ML
	PRT289F010024	bianco white	24 ML
	PRT289H010024	bronzo medio middle bronze	24 ML

ACCESSORI PRT289
PRT289 ACCESSORIES

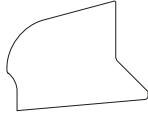
FPN289A010200		TERMINALE END COVER	COLORE COLOUR	CF PK
	TPP	FPN289A010200	neutro neutral	200 PZ

GA-9190010215		GUARNIZIONE GASKET	COLORE COLOUR	CF PK
	TP-S	GAB9190010215	bianco white	215 ML
	TP-S	GAM9190010215	marrone brown	215 ML
	TP-S	GAN9190010215	nero black	215 ML

PRT027-010024
SOGLIA A TAGLIO TERMICO
 THERMAL CUT THRESHOLD

NEW

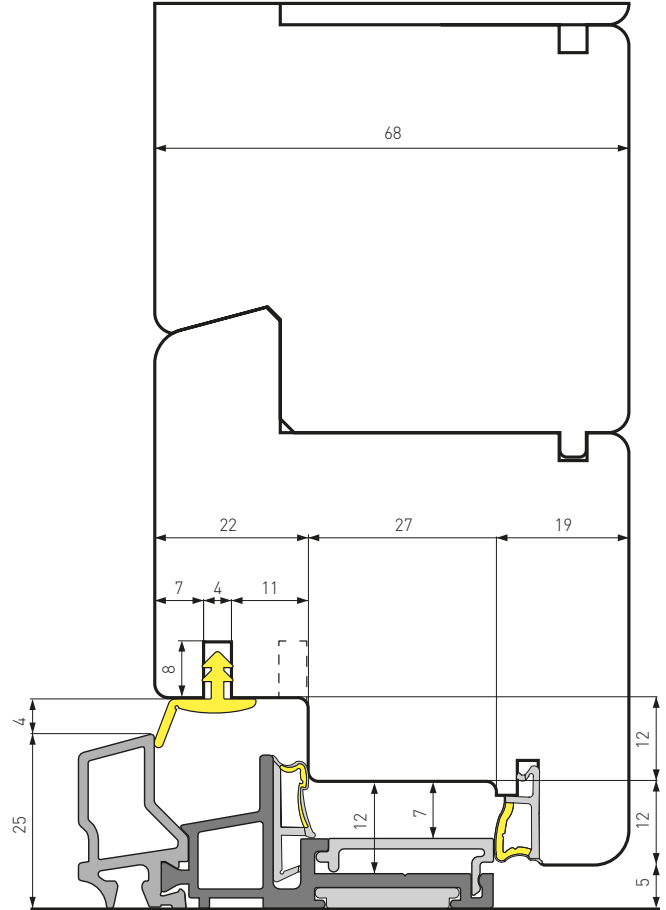
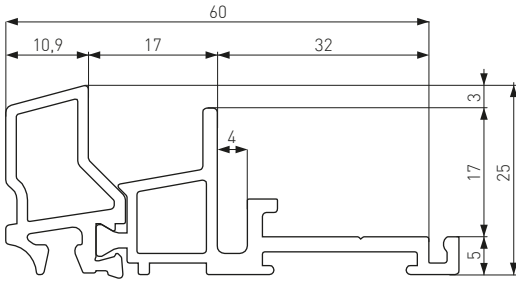

CASCADING FREUD

- CE DO Ghost
- CE DO Luce



ACCESSORI ACCESSORIES

- guarnizione gasket GA-9190010215 ↘ p. 76
- { GC-5120030220 ↘ p. 74
- { GD-5120020280 ↘ p. 74
- { GC-6100020340 ↘ p. 74
- { GD-6100010310 ↘ p. 74
- copertura cover PRT030-010024 ↘ p. 55
- piattina support PRT031X01002 ↘ p. 56

PRT027-010024	CODICE CODE	COLORE COLOUR	CF PK
	PRT027A010024	argento silver	24 ML
	PRT027C010024	bronzo scuro dark bronze	24 ML
	PRT027F010024	bianco white	24 ML

PRT030-010024	COPERTURA COVER		COLORE COLOUR	CF PK
	ALU	PRT030A010024	argento silver	24 ML
	ALU	PRT030B010024	bronzo chiaro light bronze	24 ML
	ALU	PRT030C010024	bronzo scuro dark bronze	24 ML
	ALU	PRT030F010024	bianco white	24 ML
	ALU	PRT030H010024	bronzo medio middle bronze	24 ML

PRT031X010024	PIATTINA SUPPORT		COLORE COLOUR	CF PK
	ALU	PRT031X010024	grezzo raw	24 ML

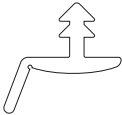
GA-9190010215	GUARNIZIONE GASKET		COLORE COLOUR	CF PK
	TP-S	GAB9190010215	bianco white	215 ML
	TP-S	GAM9190010215	marrone brown	215 ML
	TP-S	GAN9190010215	nero black	215 ML

PRT028-010024 *
SOGLIA A TAGLIO TERMICO
 THERMAL CUT THRESHOLD

*** FINO A ESAURIMENTO SCORTE**
 WHILE SUPPLIES LAST

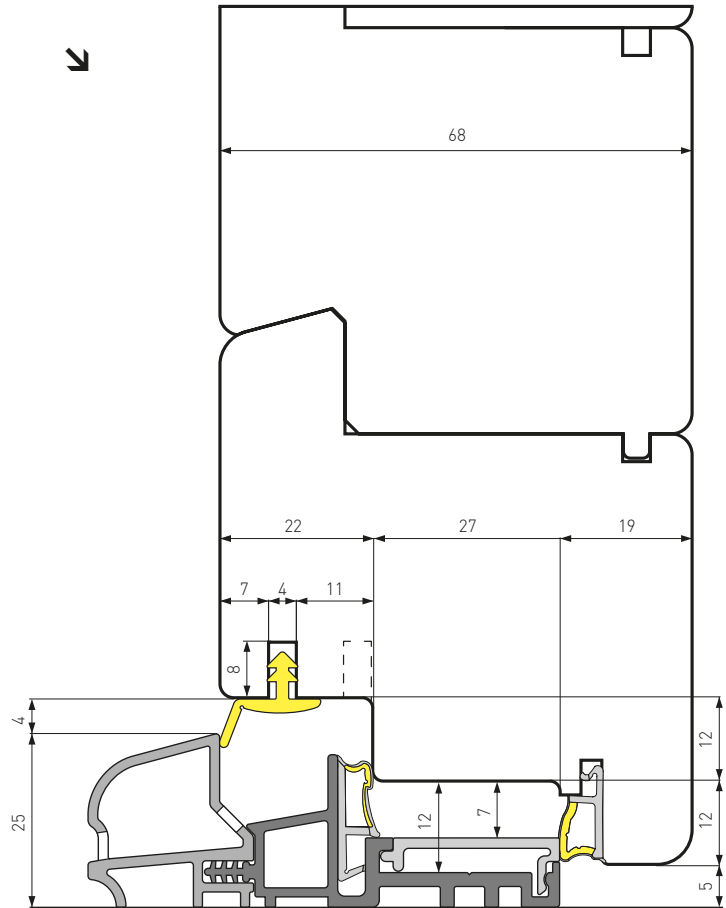
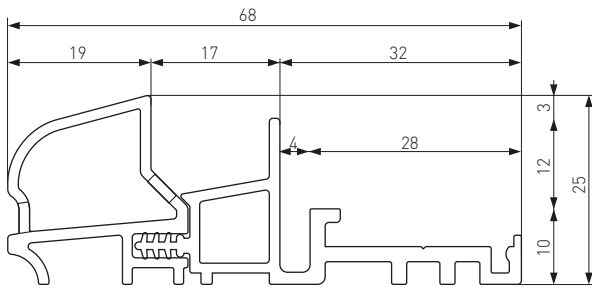

CASCADING FREUD

- CE Euronorm C-13
- CE Fox 92
- CE Freumex C-13



ACCESSORI ACCESSORIES

- terminale end cover FPN028A010200 ↘ p. 45
- guarnizione gasket GA-9190010215 ↘ p. 76
- { GC-5120030220 ↘ p. 74
- { GD-5120020280 ↘ p. 74
- { GC-6100020340 ↘ p. 74
- { GD-6100010310 ↘ p. 74
- copertura covering PRT030-010024 ↘ p. 55

PRT028-010024	CODICE CODE	COLORE COLOUR	CF PK
	PRT028B010024	bronzo chiaro light bronze	24 ML
	PRT028C010024	bronzo scuro dark bronze	24 ML
	PRT028H010024	bronzo medio middle bronze	24 ML

ACCESSORI PRT028
PRT028 ACCESSORIES

PRT030-010024	COPERTURA COVER		COLORE COLOUR	CF PK
	ALU	PRT030A010024	argento silver	24 ML
	ALU	PRT030B010024	bronzo chiaro light bronze	24 ML
	ALU	PRT030C010024	bronzo scuro dark bronze	24 ML
	ALU	PRT030F010024	bianco white	24 ML
	ALU	PRT030H010024	bronzo medio middle bronze	24 ML

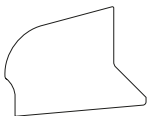
FPN028A010200	TERMINALE END COVER		COLORE COLOUR	CF PK
	TPP	FPN028A010200	neutro neutral	200 PZ

GA-9190010215	GUARNIZIONE GASKET		COLORE COLOUR	CF PK
	TP-S	GAB9190010215	bianco white	215 ML
	TP-S	GAM9190010215	marrone brown	215 ML
	TP-S	GAN9190010215	nero black	215 ML

PRT028-020024
SOGLIA A TAGLIO TERMICO
 THERMAL CUT THRESHOLD

NEW

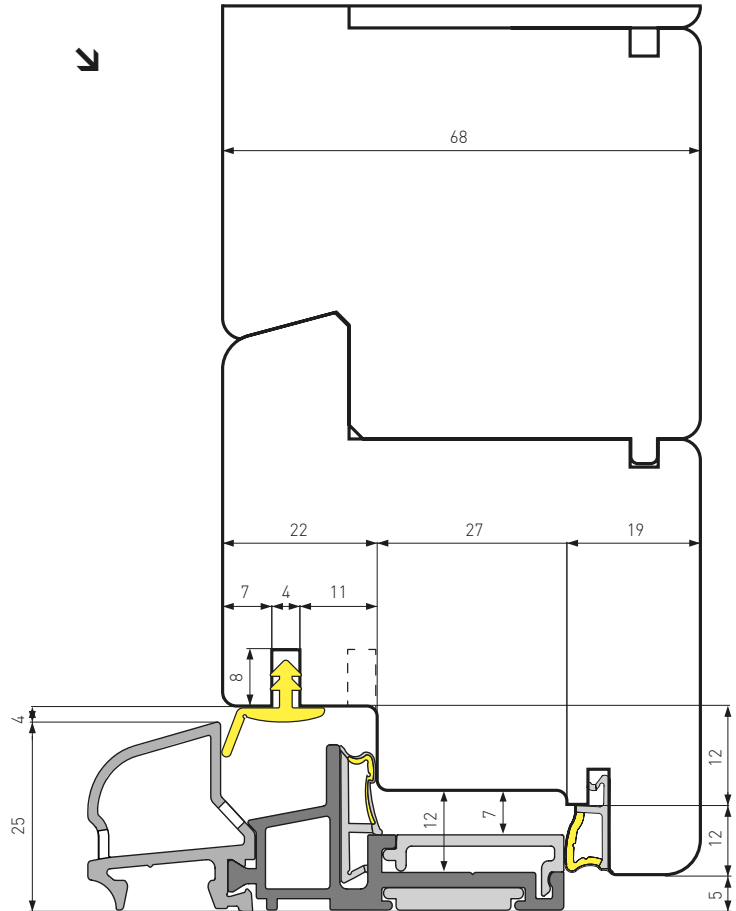
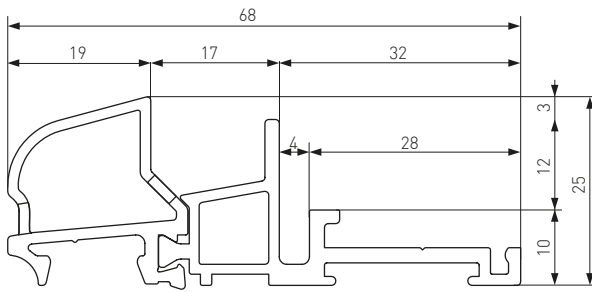

CASCADING FREUD

- CE Euronorm C-13
- CE Fox 92
- CE Freumex C-13
- CE Ghost
- CE Luce



ACCESSORI ACCESSORIES

- terminale end cover FPN028A010200 ↘ p. 47
- guarnizione gasket GA-9190010215 ↘ p. 76
- { GC-5120030220 ↘ p. 74
- { GD-5120020280 ↘ p. 74
- { GC-6100020340 ↘ p. 74
- { GD-6100010310 ↘ p. 74
- copertura cover PRT030-010024 ↘ p. 55
- piattina support PRT031X01002 ↘ p. 56

PRT028-020024	CODICE CODE	COLORE COLOUR	CF PK
	PRT028A020024	argento + ABS nero silver + black ABS	24 ML
	PRT028G020024	argento + ABS grigio silver + grey ABS	24 ML
	PRT028F020024	bianco + ABS nero white + black ABS	24 ML

PRT030-010024		COPERTURA COVER	COLORE COLOUR	CF PK
	ALU	PRT030A010024	argento silver	24 ML
	ALU	PRT030B010024	bronzo chiaro light bronze	24 ML
	ALU	PRT030C010024	bronzo scuro dark bronze	24 ML
	ALU	PRT030F010024	bianco white	24 ML
	ALU	PRT030H010024	bronzo medio middle bronze	24 ML

PRT031X010024		PIATTINA SUPPORT	COLORE COLOUR	CF PK
	ALU	PRT031X010024	grezzo raw	24 ML

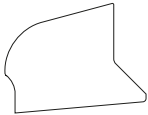
FPN028A010200		TERMINALE END COVER	COLORE COLOUR	CF PK
	TPP	FPN028A010200	neutro neutral	200 PZ

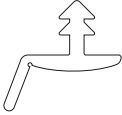
GA-9190010215		GUARNIZIONE GASKET	COLORE COLOUR	CF PK
	TP-S	GAB9190010215	bianco white	215 ML
	TP-S	GAM9190010215	marrone brown	215 ML
	TP-S	GAN9190010215	nero black	215 ML

PRT029-010024 *
SOGLIA A TAGLIO TERMICO
 THERMAL CUT THRESHOLD

*** FINO A ESAURIMENTO SCORTE**
 WHILE SUPPLIES LAST

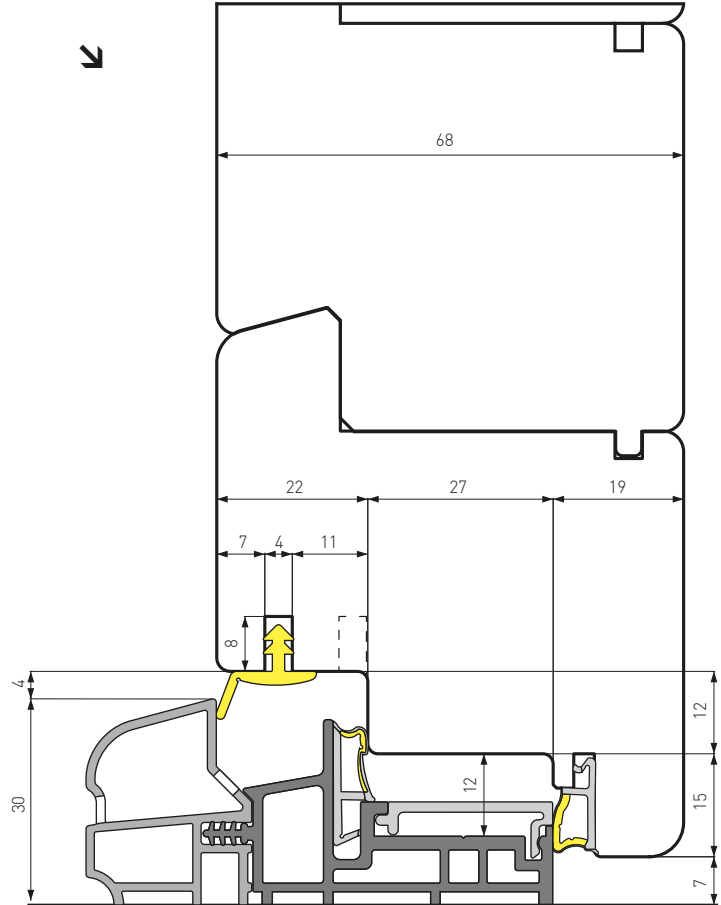
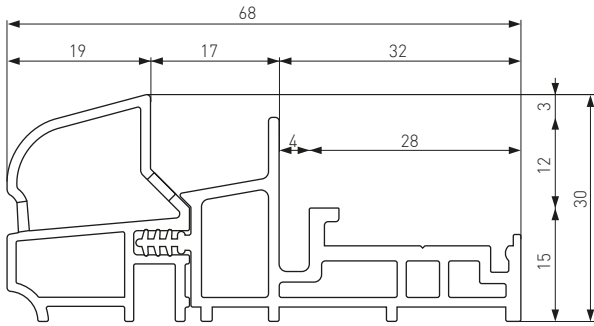

CASCADING FREUD

- CE Euronorm C-13
- CE Fox 92
- CE Freumex C-13

ACCESSORI ACCESSORIES

- terminale end cover FPN028A010200 ↘ p. 49
- guarnizione gasket GA-9190010215 ↘ p. 76
- { GC-5120030220 ↘ p. 74
- { GD-5120020280 ↘ p. 74
- { GC-6100020340 ↘ p. 74
- { GD-6100010310 ↘ p. 74
- copertura covering PRT030-010024 ↘ p. 55



PRT029-010024	CODICE CODE	COLORE COLOUR	CF PK
	PRT029A010024	argento silver	24 ML
	PRT029B010024	bronzo chiaro light bronze	24 ML
	PRT029C010024	bronzo scuro dark bronze	24 ML
	PRT029F010024	bianco white	24 ML
	PRT029H010024	bronzo medio middle bronze	24 ML

ACCESSORI PRT028
PRT028 ACCESSORIES

PRT030-010024	COPERTURA COVER		COLORE COLOUR	CF PK
	ALU	PRT030A010024	argento silver	24 ML
	ALU	PRT030B010024	bronzo chiaro light bronze	24 ML
	ALU	PRT030C010024	bronzo scuro dark bronze	24 ML
	ALU	PRT030F010024	bianco white	24 ML
	ALU	PRT030H010024	bronzo medio middle bronze	24 ML

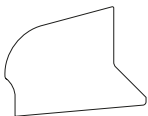
FPN028A010200	TERMINALE END COVER		COLORE COLOUR	CF PK
	TPP	FPN028A010200	neutro neutral	200 PZ

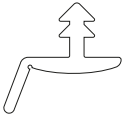
GA-9190010215	GUARNIZIONE GASKET		COLORE COLOUR	CF PK
	TP-S	GAB9190010215	bianco white	215 ML
	TP-S	GAM9190010215	marrone brown	215 ML
	TP-S	GAN9190010215	nero black	215 ML

PRT029-020024
SOGLIA A TAGLIO TERMICO
 THERMAL CUT THRESHOLD

NEW

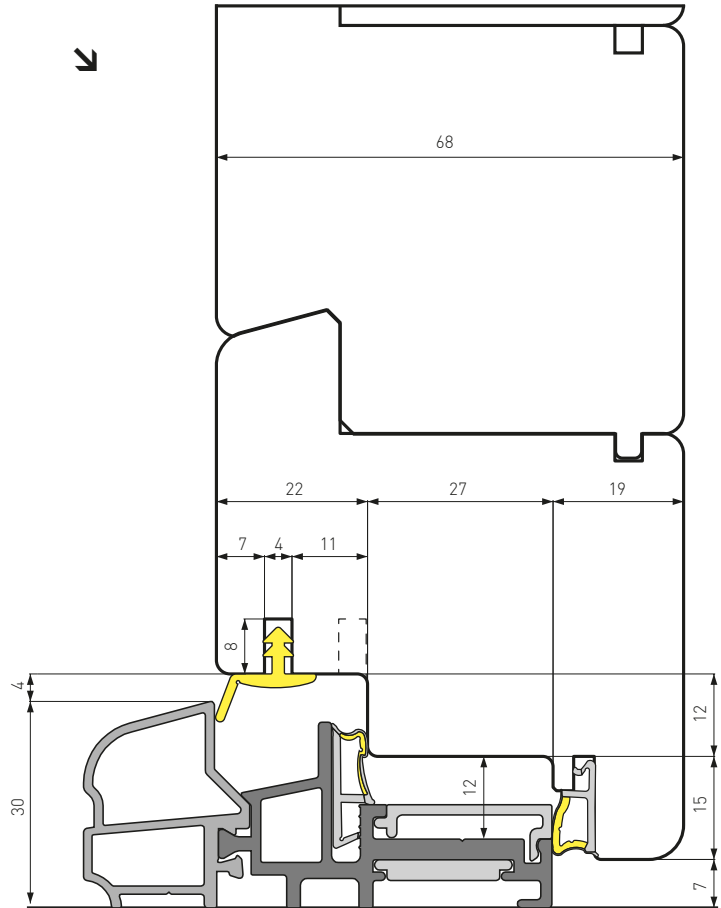
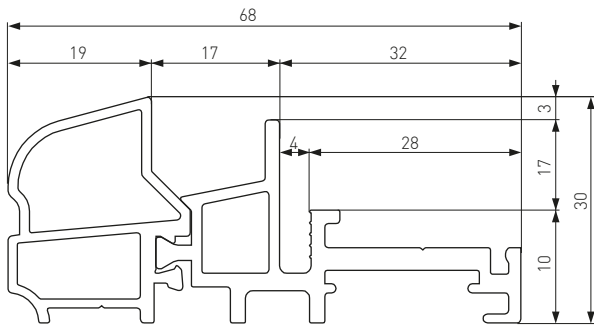

CASCADING FREUD

- CE Euronorm C-13
- CE Fox 92
- CE Freumex C-13
- CE Ghost
- CE Luce



ACCESSORI ACCESSORIES

- guarnizione gasket GA-9190010215 ↘ p. 76
- { GC-5120030220 ↘ p. 74
- { GD-5120020280 ↘ p. 74
- { GC-6100020340 ↘ p. 74
- { GD-6100010310 ↘ p. 74
- copertura cover PRT030-010024 ↘ p. 55
- piattina support PRT031X01002 ↘ p. 56

PRT029-020024	CODICE CODE	COLORE COLOUR	CF PK
	PRT029A020024	argento + ABS nero silver + black ABS	24 ML
	PRT029G020024	argento + ABS grigio silver + grey ABS	24 ML
	PRT029F020024	bianco + ABS nero white + black ABS	24 ML

PRT030-010024		COPERTURA COVER	COLORE COLOUR	CF PK
	ALU	PRT030A010024	argento silver	24 ML
	ALU	PRT030B010024	bronzo chiaro light bronze	24 ML
	ALU	PRT030C010024	bronzo scuro dark bronze	24 ML
	ALU	PRT030F010024	bianco white	24 ML
	ALU	PRT030H010024	bronzo medio middle bronze	24 ML

PRT031X010024		PIATTINA SUPPORT	COLORE COLOUR	CF PK
	ALU	PRT031X010024	grezzo raw	24 ML

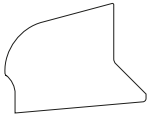
FPN028A010200		TERMINALE END COVER	COLORE COLOUR	CF PK
	TPP	FPN028A010200	neutro neutral	200 PZ

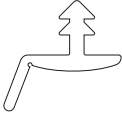
GA-9190010215		GUARNIZIONE GASKET	COLORE COLOUR	CF PK
	TP-S	GAB9190010215	bianco white	215 ML
	TP-S	GAM9190010215	marrone brown	215 ML
	TP-S	GAN9190010215	nero black	215 ML

PRT038-010024
SOGLIA A TAGLIO TERMICO
 THERMAL CUT THRESHOLD

NEW

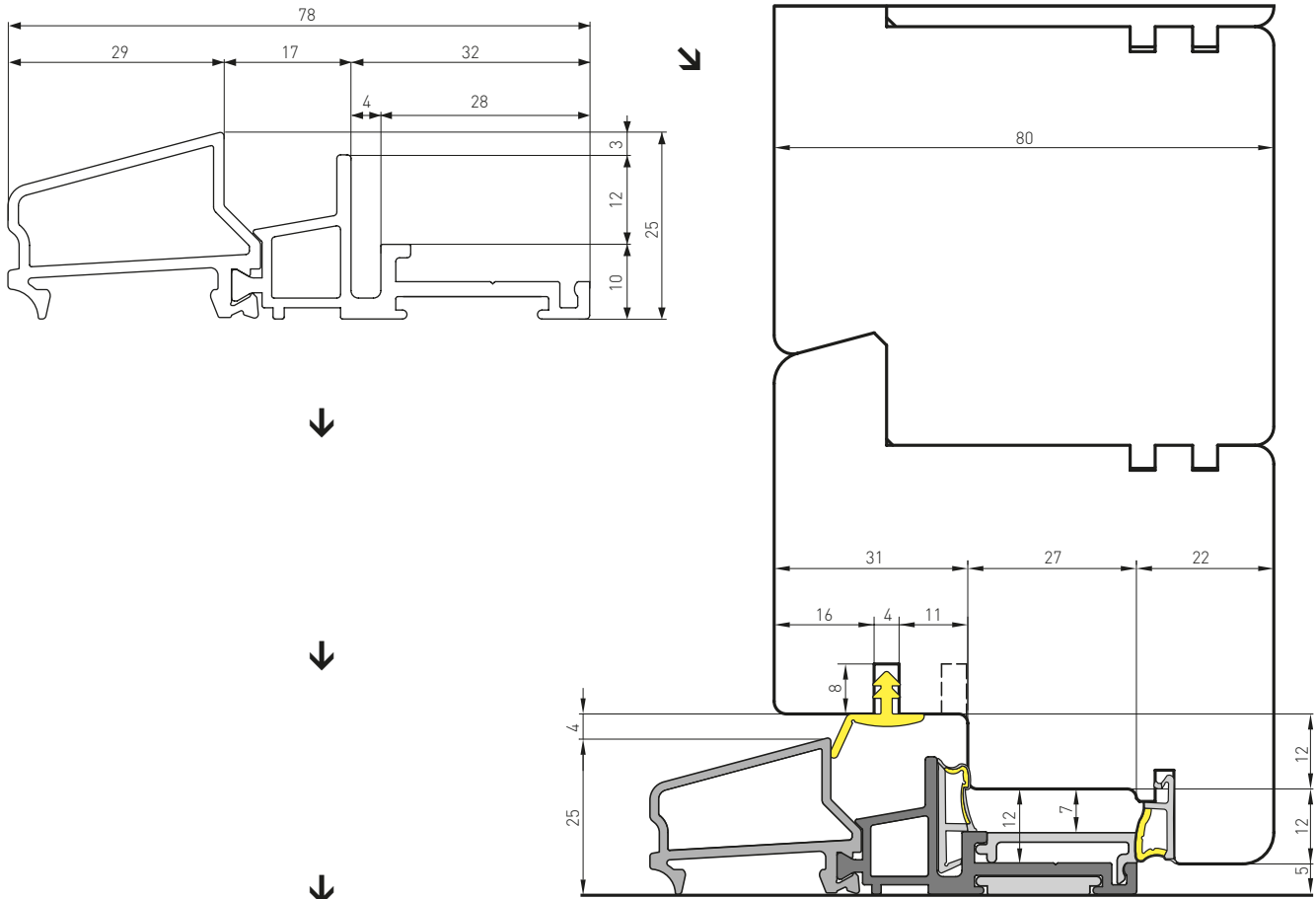

CASCADING FREUD

- CE Euronorm C-13
- CE Fox 92
- CE Freumex C-13

ACCESSORI ACCESSORIES

- guarnizione gasket GA-9190010215 ↘ p. 76
- { GC-5120030220 ↘ p. 74
- { GD-5120020280 ↘ p. 74
- { GC-6100020340 ↘ p. 74
- { GD-6100010310 ↘ p. 74
- copertura cover PRT030-010024 ↘ p. 55
- piattina support PRT031X01002 ↘ p. 56

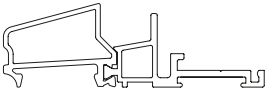
PRT038-020024	CODICE CODE	COLORE COLOUR	CF PK
	PRT038A020024	argento + ABS nero silver + black ABS	24 ML
	PRT038G020024	argento + ABS grigio silver + grey ABS	24 ML

PRT030-010024		COPERTURA COVER	COLORE COLOUR	CF PK
	ALU	PRT030A010024	argento silver	24 ML
	ALU	PRT030B010024	bronzo chiaro light bronze	24 ML
	ALU	PRT030C010024	bronzo scuro dark bronze	24 ML
	ALU	PRT030F010024	bianco white	24 ML
	ALU	PRT030H010024	bronzo medio middle bronze	24 ML

PRT031X010024		PIATTINA SUPPORT	COLORE COLOUR	CF PK
	ALU	PRT031X010024	grezzo raw	24 ML

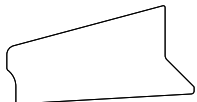
FPN038A010200		TERMINALE END COVER	COLORE COLOUR	CF PK
	TPP	FPN038A010200	neutro neutral	200 PZ

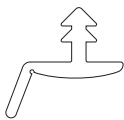
GA-9190010215		GUARNIZIONE GASKET	COLORE COLOUR	CF PK
	TP-S	GAB9190010215	bianco white	215 ML
	TP-S	GAM9190010215	marrone brown	215 ML
	TP-S	GAN9190010215	nero black	215 ML



ACCESSORI GOCCIOLATOI E SOGLIE
WEATHER BARS AND THRESHOLDS ACCESSORIES

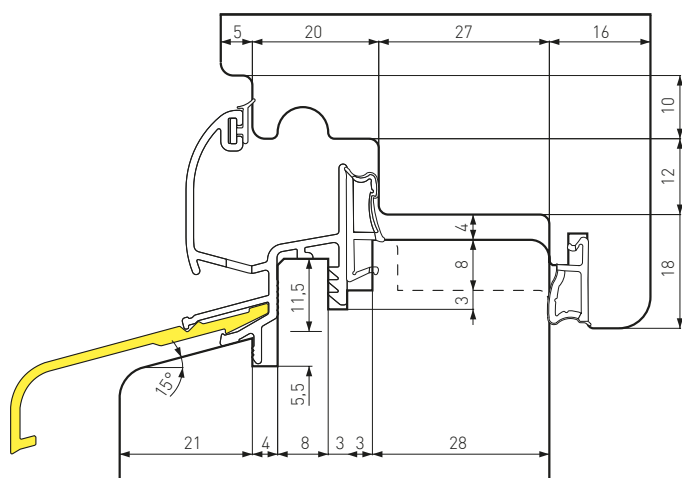

APPLICAZIONE A

APPLICATION TO

- PRG311-010024
- PRG312-010024
- PRG313-010024
- PRG314-010024
- PRG317-010024
- PRG318-010024
- PRG367-010024

PRG323-010024	GRONDALINO WEATHER BAR SILL		COLORE COLOUR	CF PK
	ALU	PRG323A010024	argento silver	24 ML
	ALU	PRG323B010024	bronzo chiaro light bronze	24 ML
	ALU	PRG323C010024	bronzo scuro dark bronze	24 ML
	ALU	PRG323F010024	bianco white	24 ML
	ALU	PRG323H010024	bronzo medio middle bronze	24 ML

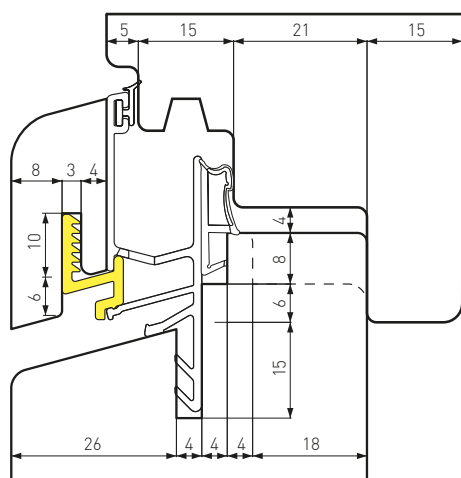

APPLICAZIONE A

APPLICATION TO

- PRG311-010024
- PRG313-010024
- PRG317-010024
- PRG367-010024

FPA315A010200	CLIP CLIP HOLDER		COLORE COLOUR	CF PK
	ALU	FPA315A010200	grezzo raw	200 PZ

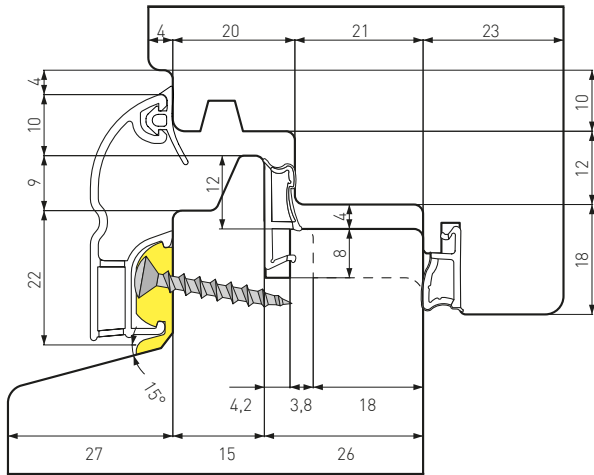

APPLICAZIONE A
 APPLICATION TO
 PRG333-010024
 PRG334-010024

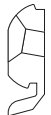
FPA333A010024	CLIP CLIP HOLDER		COLORE COLOUR	CF PK
	NYLON	FPA333A010200	neutro neutral	200 PZ

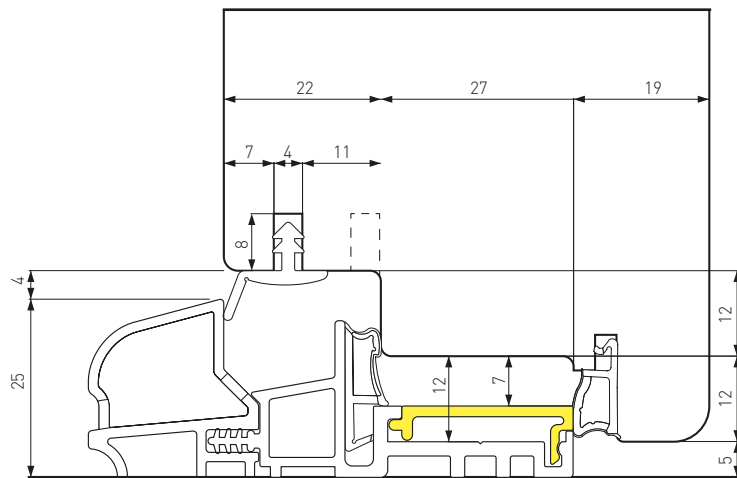

APPLICAZIONE A
 APPLICATION TO
 PRT027-010024
 PRT028-010024
 PRT028-020024
 PRT029-010024
 PRT029-020024
 PRT038-010024

PRT030-010024	COPERTURA COVER		COLORE COLOUR	CF PK
	ALU	PRT030A010024	argento silver	24 ML
	ALU	PRT030B010024	bronzo chiaro light bronze	24 ML
	ALU	PRT030C010024	bronzo scuro dark bronze	24 ML
	ALU	PRT030F010024	bianco white	24 ML
	ALU	PRT030H010024	bronzo medio middle bronze	24 ML

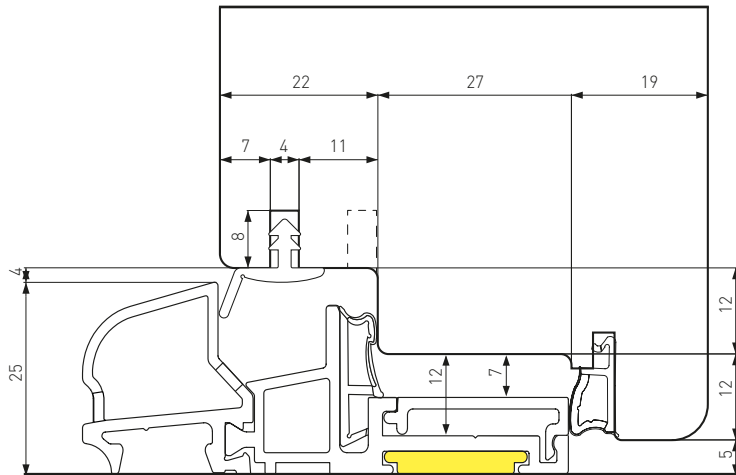
**APPLICAZIONE A**

APPLICATION TO

PRT027-010024

PRT028-020024

PRT029-020024

PRT038-010024

PRT031X010024		PIATTINA SUPPORT	COLORE COLOUR	CF PK
	ALU	PRT031X010024	grezzo raw	24 ML

PROFILI FERMAVETRO
GLASS PROFILES

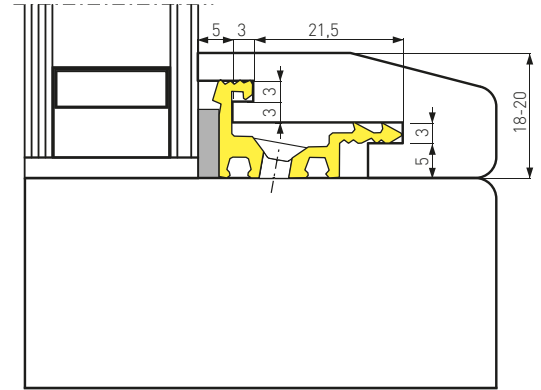
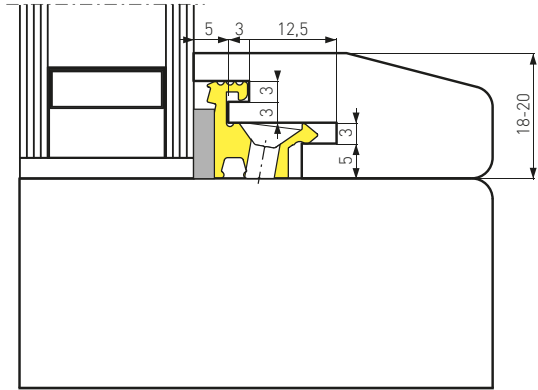
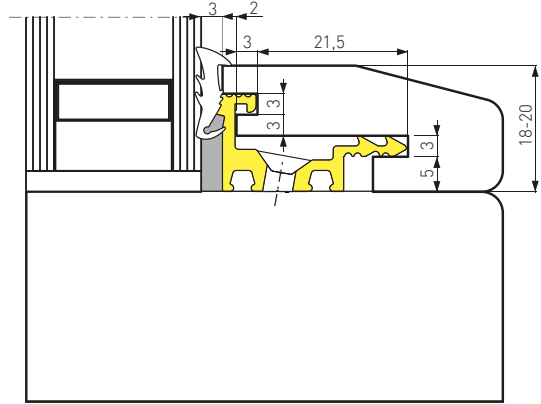
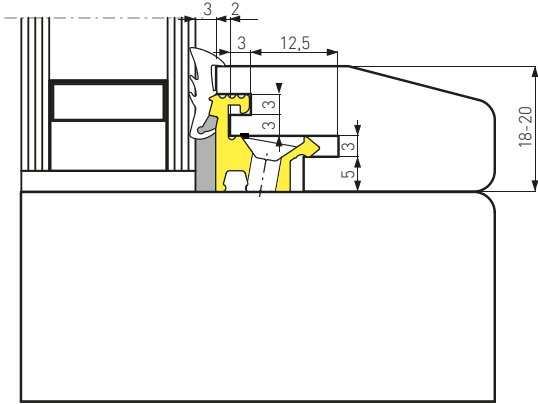

PFV1614010024		COLORE COLOUR		CF PK
	ALU	PFV1614010024	grezzo raw	24 ML

PFV2714010024		COLORE COLOUR		CF PK
	ALU	PFV2714010024	grezzo raw	24 ML

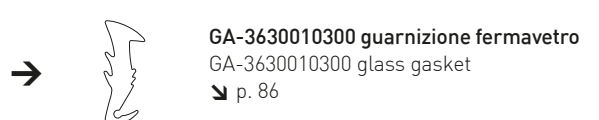

SOGLIE GUTMANN
GUTMANN THRESHOLDS

G U T M

1 A N N

Le soglie GUTMANN soddisfano i requisiti predisposti dalla normativa DIN 18040 1 + 2, relativa alle costruzioni senza barriere architettoniche. Resistono all'acqua per livelli superiori a 1350 Pa, certificato IFT, con una guarnizione in gomma cellulare nella sezione della soglia.

GUTMANN thresholds are suitable for barrier-free building by DIN 18040 part 1 + 2.
Fulfilled highest watertightness up to 1350 Pa, IFT-certicated, with a cellular rubber gasket in the section of the threshold.

CARATTERISTICHE

FEATURES

Riduzione del punto di rugiada o della formazione della condensa attraverso un'ottima gestione isotermica.
Punti di fissaggio nascosti nella finestra con l'applicazione di una piattina di supporto.
Controlavorazione predisposta attraverso l'applicazione di tappi di testa.
Elementi di protezione intercambiabili e disponibili in alluminio e in plastica.
Plastiche utilizzate prive di PVC.

Reduction of dew point performance or condensate formation via an optimal isothermal run.
Concealed screwing on the frame via application of the threshold support.
Counter-milling dispensed by using the filler pieces.
Exchangeable step protection optional plastic or aluminium.
Used plastic is PVC free.

LISTA DELLE SOGLIE GUTMANN DISPONIBILI

LIST OF AVAILABLE GUTMANN THRESHOLDS

WESER TI con accessori;
WESER 20 TI con accessori;
SERIE INT: soglie da interno INT UP 32, INT P 1668, INT P 440, INT P 441, INT P 60-15 con accessori.

WESER TI with accessories;
WESER 20 TI with accessories;
INT SERIES: Thresholds for interiors INT UP 32, INT P 1668, INT P 440, INT P 441, INT P 60-15 with accessories.



G U T M A N N

WESER TI
CON ACCESSORI
 WITH ACCESSORIES

WESER 65 TI

alluminio e ABS
 aluminium and ABS

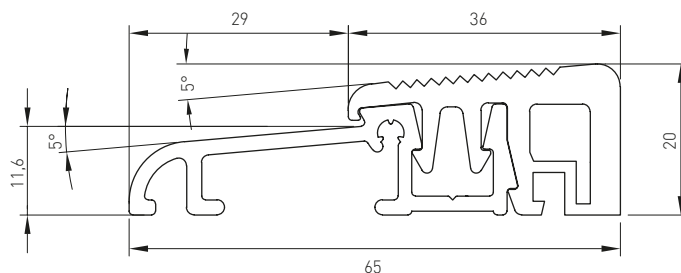

WESER 75 TI

alluminio e ABS
 aluminium and ABS

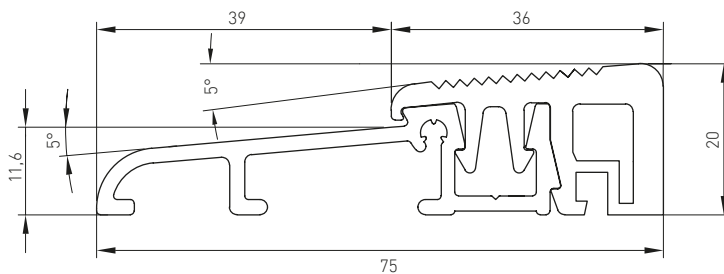

WESER 95 TI

alluminio e ABS
 aluminium and ABS

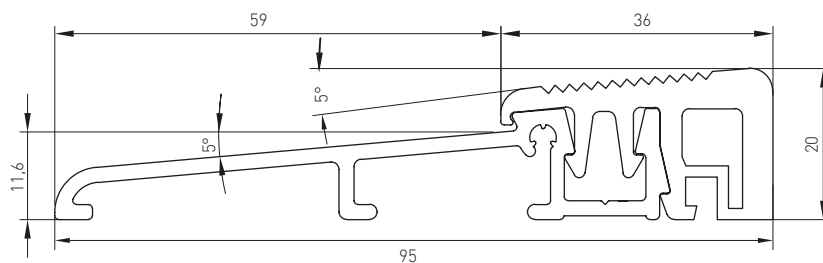

WESER TI	COLORE COLOUR	argento + ABS nero silver + black ABS	CF PK	6 ML
-----------------	----------------------	---------------------------------------	--------------	-------------

<p>TD 50</p> <p>TERMINALE END COVER</p>		COLORE COLOUR	CF PK
	EDPM	nero black	1 ML

<p>SH Weser</p> <p>PIATTINA SUPPORT</p>		COLORE COLOUR	CF PK
	ABS	nero black	1 PZ

WESER 20 TI
CON ACCESSORI
 WITH ACCESSORIES

WESER 65/20 TI

alluminio e ABS
 aluminium and ABS

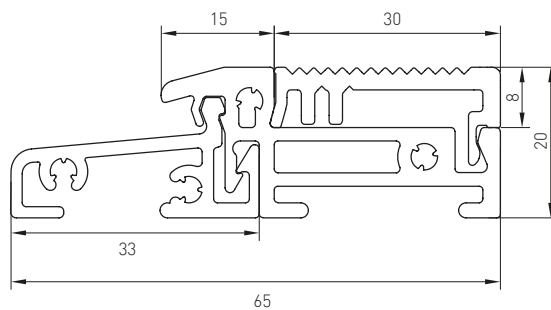

WESER 75/20 TI

alluminio e ABS
 aluminium and ABS

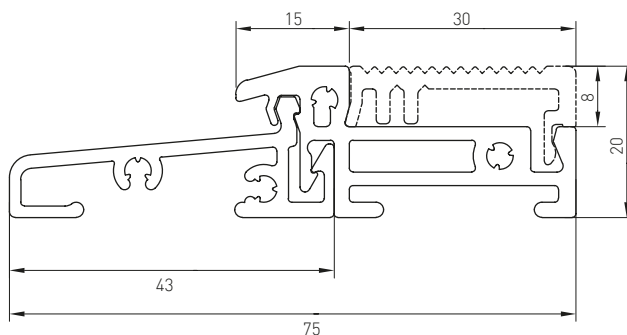

WESER 95/20 TI

alluminio e ABS
 aluminium and ABS

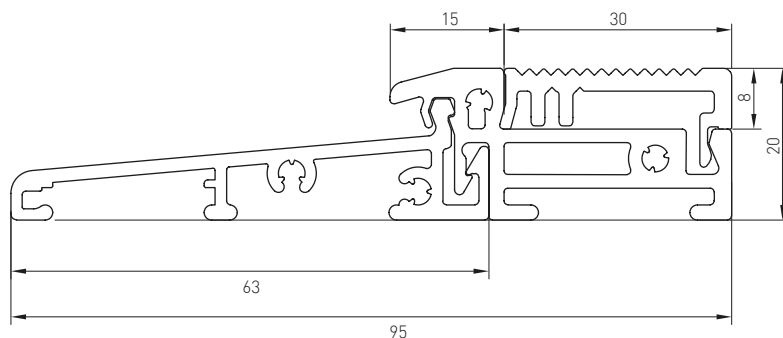

WESER 115/20 TI

alluminio e ABS
 aluminium and ABS

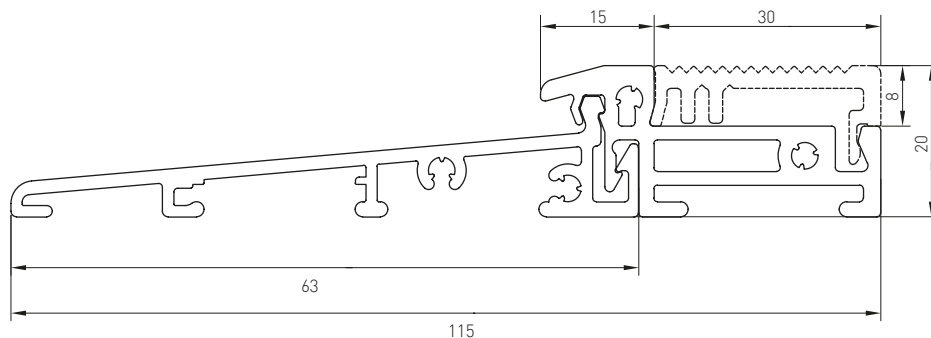

WESER 20 TI	COLORE COLOUR	argento + ABS nero silver + black ABS	CF PK	6 ML
--------------------	----------------------	---------------------------------------	--------------	-------------

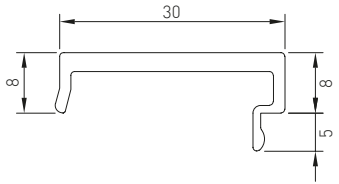
WESER D 8	COPERTURA COVER	COLORE COLOUR	CF PK
	ALU	argento silver	6 ML

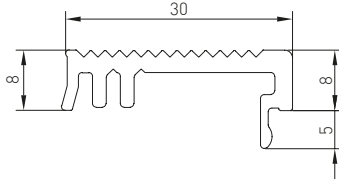
WESER D 8 ABS	COPERTURA COVER	COLORE COLOUR	CF PK
	ABS	nero black	6 ML

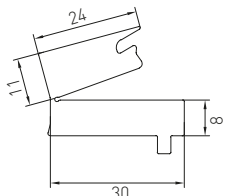
WESER TD 8/11	TERMINALE END COVER	COLORE COLOUR	CF PK
	EPDM	nero black	1 ML

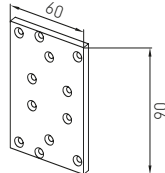
WESER SH 70	PIATTINA FASTENING PART	COLORE COLOUR	CF PK
	ALU	argento silver	1 PZ

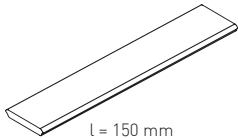
WESER BS 21.4	PIATTINA THRESHOLD SUPPORT	COLORE COLOUR	CF PK
	ALU	argento silver	1 PZ

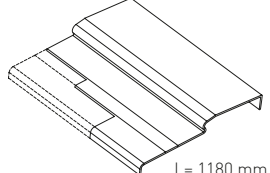
WESER BSP 97.21	COPERTURA SEALING PART	COLORE COLOUR	CF PK
	EPDM	nero black	1 PZ

SERIE INT
SOGLIE DA INTERNO CON ACCESSORI
 THRESHOLDS FOR INTERIOR WITH ACCESSORIES

INT UP 32

alluminio aluminium

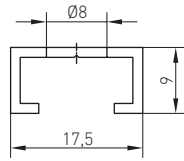

INT P 1668

alluminio aluminium

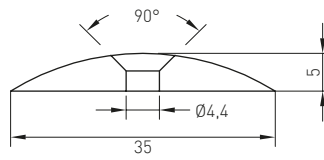

INT P 440

alluminio aluminium

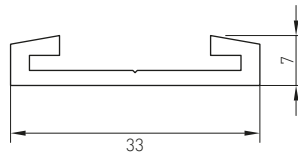

INT P 441

alluminio aluminium

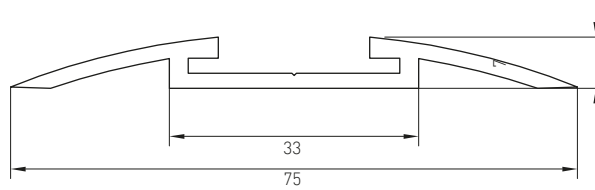

INT P 60-15

alluminio aluminium

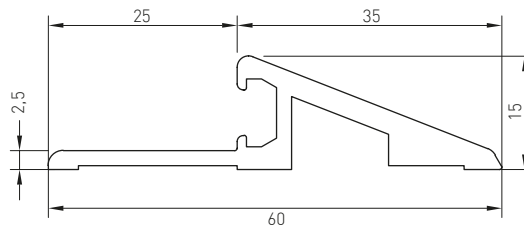

INT	COLORE COLOUR	argento silver	CF PK	6 ML
------------	----------------------	----------------	--------------	-------------

INT M5x37	VITE DI FISSAGGIO ADJUSTING SCREW	COLORE COLOUR	CF PK
	acciaio inossidabile stainless steel	grezzo raw	1 PZ

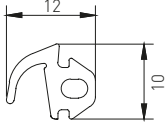
INT TD 15	GUARNIZIONE GASKET	COLORE COLOUR	CF PK
	EPDM	nero black	1 ML

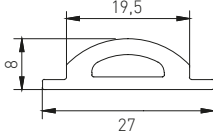
INT TD 20	GUARNIZIONE GASKET	COLORE COLOUR	CF PK
	EPDM	nero black	1 ML

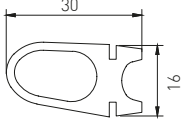
INT TD 32	GUARNIZIONE GASKET	COLORE COLOUR	CF PK
	EPDM	nero black	1 ML

PROFILO DI CHIUSURA PER ALZANTE SCORREVOLE CON ACCESSORI
 LOCKING PROFILE FOR LIFTING SLIDING DOORS WITH ACCESSORIES

MV 26.11

alluminio aluminium

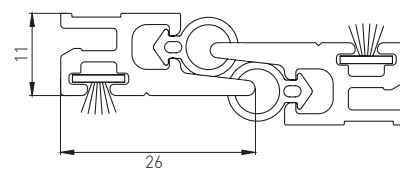
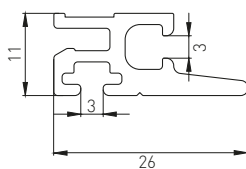

MV 26.11	COLORE COLOUR	argento silver	CF PK	6 ML
-----------------	----------------------	----------------	--------------	-------------

HA 3010	GUARNIZIONE GASKET	COLORE COLOUR	CF PK
	EPDM	nero black	1 ML

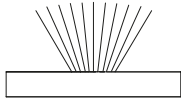
RB 1	SPAZZOLINO 5 MM BRUSH STRIP 5 MM	COLORE COLOUR	CF PK
	PVC	nero black	1 ML

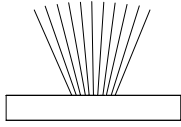
RB 2	SPAZZOLINO 7 MM BRUSH STRIP 7 MM	COLORE COLOUR	CF PK
	PVC	nero black	1 ML

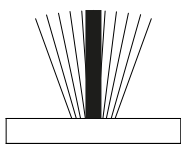
RB 2 MS	SPAZZOLINO 8 MM BRUSH STRIP 8 MM	COLORE COLOUR	CF PK
 <p>con ponte with bridge</p>	PVC	nero black	1 ML



GUARNIZIONI
GASKETS

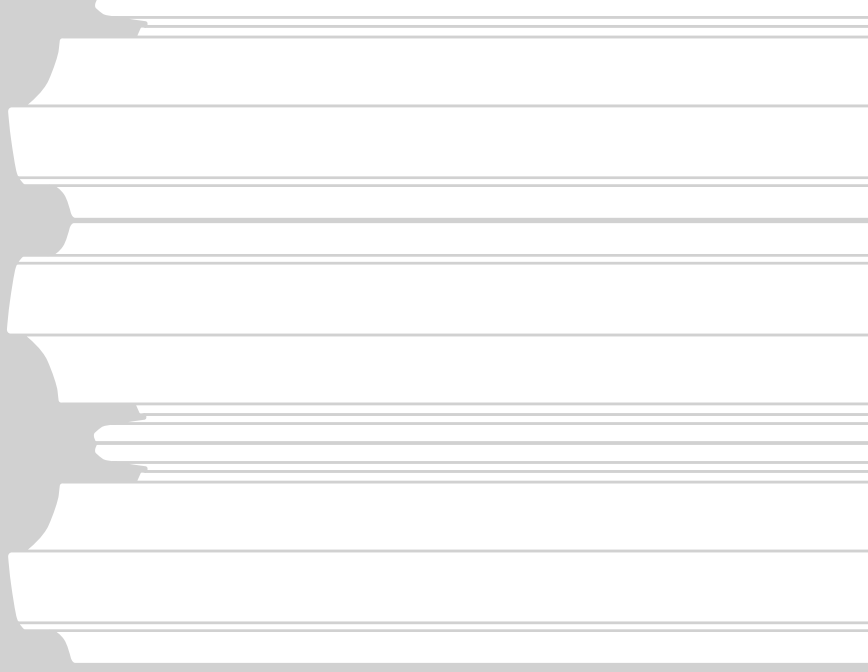



GUARNIZIONI
GASKETS

GC-5120040220			COLORE COLOUR	CF PK	↘ triestruso tri-extruded ↘ aria 5 mm battuta 12 mm cava 4x8 mm
	TP-S	GCB5120040220	bianco white	220 ML	
	TP-S	GCG5120040220	grigio grey	220 ML	
	TP-S	GCM5120040220	marrone brown	220 ML	
	TP-S	GCN5120040220	nero black	220 ML	

GL-5120010220 → ECONOMICA LOW-COST			COLORE COLOUR	CF PK	↘ triestruso tri-extruded ↘ aria 5 mm battuta 12 mm cava 4x8 mm
	TP-S	GLB5120010220	bianco white	220 ML	
	TP-S	GLG5120010220	grigio grey	220 ML	
	TP-S	GLM5120010220	marrone brown	220 ML	
	TP-S	GLN5120010220	nero black	220 ML	

GD-5120030280			COLORE COLOUR	CF PK	↘ triestruso tri-extruded ↘ aria 5 mm battuta 12 mm cava 4x8 mm
	TP-S	GDB5120030280	bianco white	280 ML	
	TP-S	GDG5120030280	marrone brown	280 ML	
	TP-S	GDM5120030280	nero black	280 ML	

GC-6040030400			COLORE COLOUR	CF PK	↘ triestruso tri-extruded ↘ aria 6 mm cava 3x5 mm
	TP-S	GCB6040030400	bianco white	400 ML	
	TP-S	GCG6040030400	grigio grey	400 ML	
	TP-S	GCM6040030400	marrone brown	400 ML	
	TP-S	GCN6040030400	nero black	400 ML	

GL-6040010400 → ECONOMICA LOW-COST			COLORE COLOUR	CF PK	↘ triestruso tri-extruded ↘ aria 6 mm cava 3x5 mm
	TP-S	GLB6040010400	bianco white	400 ML	
	TP-S	GLG6040010400	grigio grey	400 ML	
	TP-S	GLM6040010400	marrone brown	400 ML	
	TP-S	GLN6040010400	nero black	400 ML	

GC-6100030340			COLORE COLOUR	CF PK	↓ triestruso tri-extruded ↓ aria 6 mm battuta 10 mm cava 3x5 mm
	TP-S	GCB6100030340	bianco white	340 ML	
	TP-S	GCG6100030340	grigio grey	340 ML	
	TP-S	GCM6100030340	marrone brown	340 ML	
	TP-S	GCN6100030340	nero black	340 ML	

GL-6100010340 → ECONOMICA LOW-COST			COLORE COLOUR	CF PK	↓ triestruso tri-extruded ↓ aria 6 mm battuta 10 mm cava 3x5 mm
	TP-S	GLB6100010340	bianco white	340 ML	
	TP-S	GLG6100010340	grigio grey	340 ML	
	TP-S	GLM6100010340	marrone brown	340 ML	
	TP-S	GLN6100010340	nero black	340 ML	

GD-6100030310			COLORE COLOUR	CF PK	↓ triestruso tri-extruded ↓ aria 6 mm battuta 10 mm cava 3x5 mm
	TP-S	GDB6100030310	bianco white	310 ML	
	TP-S	GDM6100030310	marrone brown	310 ML	
	TP-S	GDN6100030310	nero black	310 ML	

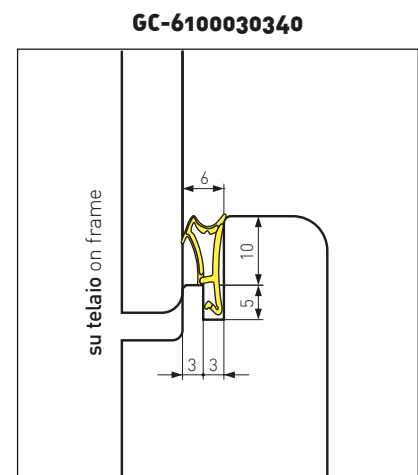
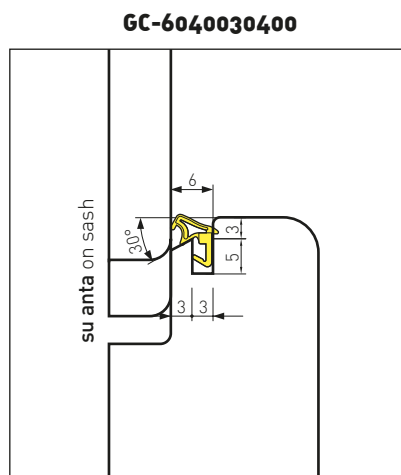
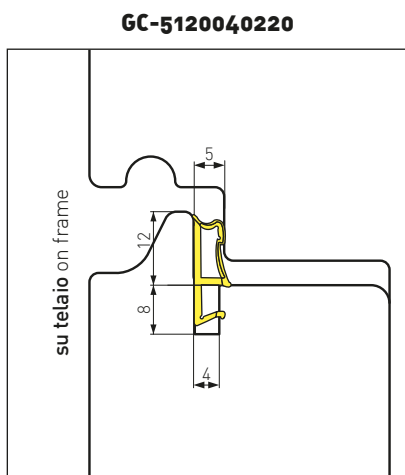

GA-1860010220			COLORE COLOUR	CF PK	↘ monoestruso mono-extruded ↘ spessore 3 mm battuta 18 mm cava 3x6 mm
 CE DG	TPV	GAB1860010220	bianco white	220 ML	
	TPV	GAM1860010220	marrone brown	220 ML	
	TPV	GAN1860010220	nero black	220 ML	

GA-2060010220			COLORE COLOUR	CF PK	↘ monoestruso mono-extruded ↘ spessore 3 mm battuta 20 mm cava 3x6 mm
 CE DG	TPV	GAB2060010220	bianco white	220 ML	
	TPV	GAM2060010220	marrone brown	220 ML	
	TPV	GAN2060010220	nero black	220 ML	

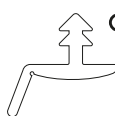
GA-9190020215			COLORE COLOUR	CF PK	↘ monoestruso mono-extruded ↘ battuta 11 mm cava 4x6 mm
 CE DG	TP-S	GAB9190020215	bianco white	215 ML	
	TP-S	GAM9190020215	marrone brown	215 ML	
	TP-S	GAN9190020215	nero black	215 ML	

GA-8600010200			COLORE COLOUR	CF PK	↘ monoestruso mono-extruded ↘ spessore 1 mm cava 2 mm
 CE DG	TP-S	GAB8600020200	bianco white	200 ML	
	TP-S	GAG8600020200	grigio grey	200 ML	
	TP-S	GAM8600020200	marrone brown	200 ML	
	TP-S	GAN8600020200	nero black	200 ML	

GA-9100030450			COLORE COLOUR	CF PK	↘ monoestruso mono-extruded ↘ spessore 1 mm cava 3 mm
 CE DG	TP-S	GAB9100030450	bianco white	450 ML	
	TP-S	GAG9100030450	grigio grey	450 ML	
	TP-S	GAM9100030450	marrone brown	450 ML	
	TP-S	GAN9100030450	nero black	450 ML	

GE-5040030400			COLORE COLOUR	CF PK	↘ monoestruso mono-extruded ↘ spessore 6 mm cava 2,2x6 mm
 CE DG	TP-S	GEB5040030400	bianco white	400 ML	
	TP-S	GEM5040030400	marrone brown	400 ML	
	TP-S	GEN5040030400	nero black	400 ML	
	TP-S	GET5040030400	trasparente transparent	400 ML	

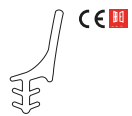
GA-9070020480			COLORE COLOUR	CF PK	↙ monoestruso mono-extruded ↘ battuta 1 mm cava 3x7 mm
	TP-S	GAB9070020480	bianco white	480 ML	
	TP-S	GAM9070020480	marrone brown	480 ML	
	TP-S	GAN9070020480	nero black	480 ML	

GA-9080010480			COLORE COLOUR	CF PK	↙ monoestruso mono-extruded ↘ battuta 1 mm cava 3x7 mm
	TP-S	GAB9080020480	bianco white	480 ML	
	TP-S	GAM9080020480	marrone brown	480 ML	
	TP-S	GAN9080020480	nero black	480 ML	

GA-4450010350			COLORE COLOUR	CF PK	↙ monoestruso mono-extruded ↘ battuta 1 mm cava 4x6,5 mm
	TPV	GAB4450010350	bianco white	350 ML	
	TPV	GAM4450010350	marrone brown	350 ML	
	TPV	GAN4450010350	nero black	350 ML	



GA-1860010220

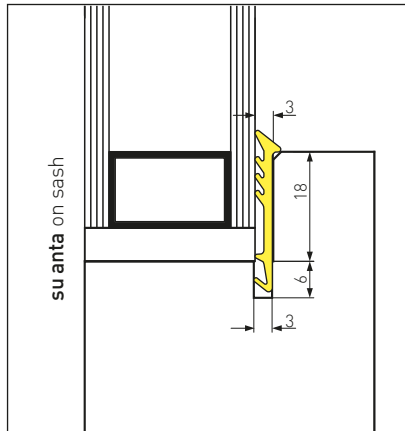

GA-9190020215

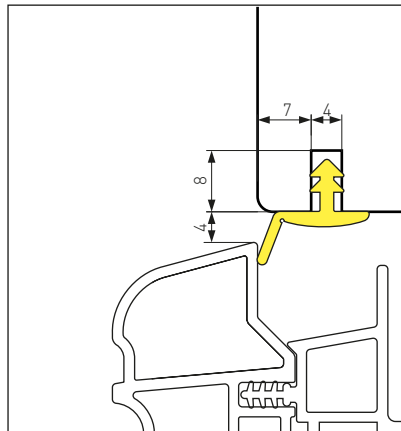

GA-8600020200

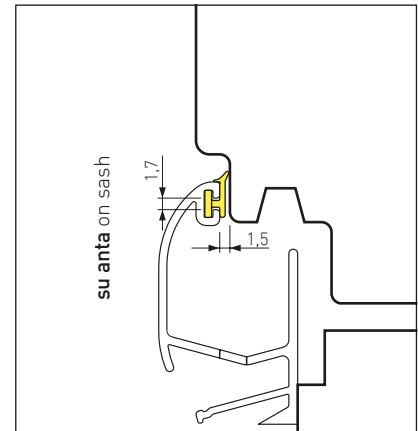

GA-9100030450

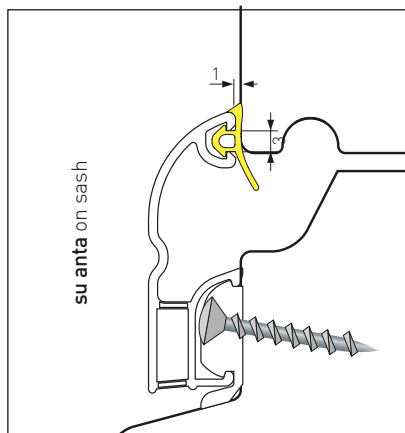

GE-5040030400

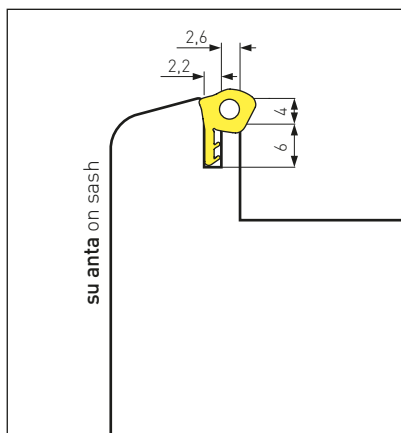

GA-9070020480

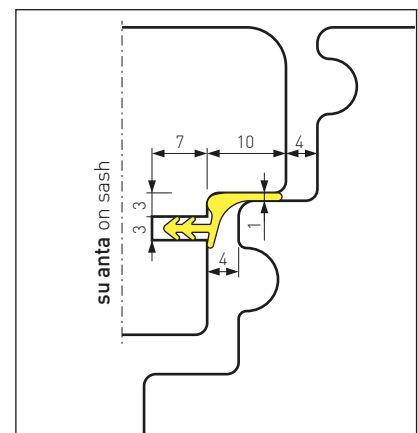

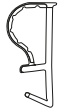

GC-4110020320			COLORE COLOUR	CF PK	↘ triestruso tri-extruded ↘ aria 4 mm battuta 11 mm cava 4x8 mm
	TP-S	GCB4110020320	bianco white	320 ML	
	TP-S	GCM4110020320	marrone brown	320 ML	
	TP-S	GCN4110020320	nero black	320 ML	

GD-4110010300 *			COLORE COLOUR	CF PK	↘ triestruso tri-extruded ↘ aria 4 mm battuta 11 mm cava 4x8 mm
	TPV	GDB4110010300	bianco white	300 ML	
	TPV	GDM4110010300	marrone brown	300 ML	

*** FINO A ESAURIMENTO SCORTE**
WHILE SUPPLIES LAST

GC-4140020240			COLORE COLOUR	CF PK	↘ triestruso tri-extruded ↘ aria 4 mm battuta 14 mm cava 4x8 mm
	TP-S	GCB4140020240	bianco white	240 ML	
	TP-S	GCM4140020240	marrone brown	240 ML	
	TP-S	GCN4140020240	nero black	240 ML	

GC-4150020250			COLORE COLOUR	CF PK	↘ triestruso tri-extruded ↘ aria 4 mm battuta 15 mm cava 4x8 mm
	TP-S	GCB4150020250	bianco white	250 ML	
	TP-S	GCM4150020250	marrone brown	250 ML	
	TP-S	GCN4150020250	nero black	250 ML	

GD-4150010230 *			COLORE COLOUR	CF PK	↘ triestruso tri-extruded ↘ aria 4 mm battuta 15 mm cava 4x8 mm
	TPV	GDB4150010230	bianco white	230 ML	
	TPV	GDM4150010230	marrone brown	230 ML	

*** FINO A ESAURIMENTO SCORTE**
WHILE SUPPLIES LAST

GA-4180010225			COLORE COLOUR	CF PK	↓ monoestruso mono-extruded ↓ aria 4 mm battuta 18 mm cava 4x8 mm
	TPV	GAB4180010225	bianco white	225 ML	
	TPV	GAM4180010225	marrone brown	225 ML	

GC-4180020200			COLORE COLOUR	CF PK	↓ coestruso co-extruded ↓ aria 4 mm battuta 18 mm cava 4x8 mm
	TP-S	GCB4180020200	bianco white	200 ML	
	TP-S	GCM4180020200	marrone brown	200 ML	
	TP-S	GCN4180020200	nero black	200 ML	

GA-5150010225			COLORE COLOUR	CF PK	↓ monoestruso mono-extruded ↓ aria 5 mm battuta 15 mm cava 5x8 mm
	TPV	GAB5150010225	bianco white	225 ML	
	TPV	GAM5150010225	marrone brown	225 ML	

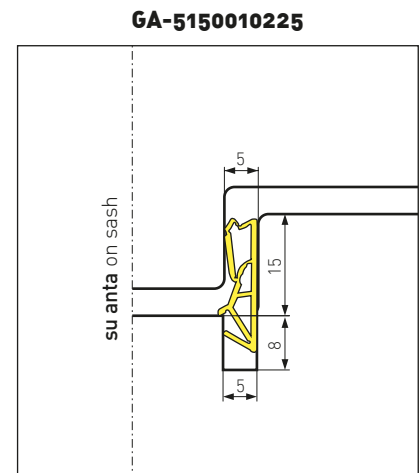
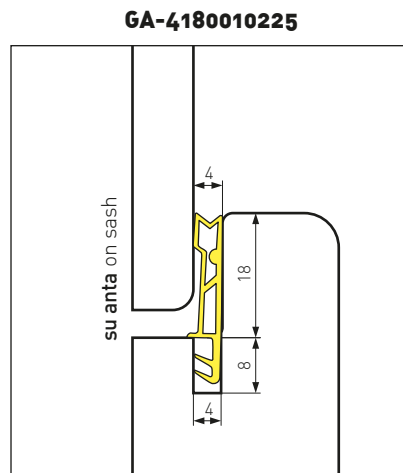
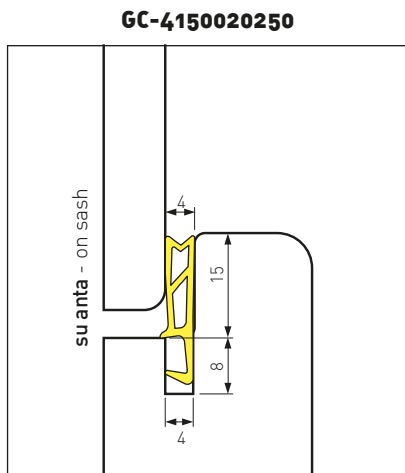

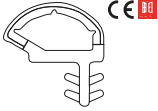
GD-3100020400			COLORE COLOUR	CF PK	↘ triestruso tri-extruded ↘ aria 4 mm battuta 10 mm cava 3,2x4,2 mm
	TP-S	GDB3100020400	bianco white	400 ML	
	TP-S	GDM3100020400	marrone brown	400 ML	
	TP-S	GDN3100020400	nero black	400 ML	

GA-3120020300			COLORE COLOUR	CF PK	↘ monoestruso mono-extruded ↘ battuta 12 mm cava 4x8 mm
	TP-S	GAB3120020300	bianco white	300 ML	
	TP-S	GAM3120020300	marrone brown	300 ML	
	TP-S	GAN3120020300	nero black	300 ML	

GA-3125020300			COLORE COLOUR	CF PK	↘ monoestruso mono-extruded ↘ battuta 12 mm cava 4x8 mm
	TP-S	GAB3125020300	bianco white	300 ML	
	TP-S	GAM3125020300	marrone brown	300 ML	
	TP-S	GAN3125020300	nero black	300 ML	

GA-3310020100			COLORE COLOUR	CF PK	↘ monoestruso mono-extruded ↘ aria 3 mm cava 3x7 mm
	TP-S	GAB3310020100	bianco white	100 ML	
	TP-S	GAM3310020100	marrone brown	100 ML	
	TP-S				

GA-3320020190			COLORE COLOUR	CF PK	↘ monoestruso mono-extruded ↘ aria 3 mm cava 3x6 mm
	TP-S	GAB3320020190	bianco white	190 ML	
	TP-S	GAM3320020190	marrone brown	190 ML	

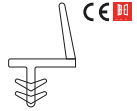
GE-4300020450			COLORE COLOUR	CF PK	↙ coestruso co-extruded ↘ aria 3 mm cava 4x6,5 mm
	TP-S	GEB4300020450	bianco white	450 ML	
	TP-S	GEM4300020450	marrone brown	450 ML	
		GEN4300020450	nero black	450 ML	



GA-3120020300

GA-3125020300

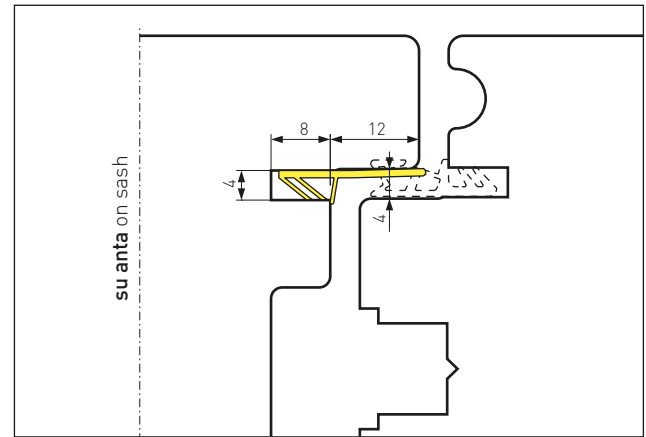
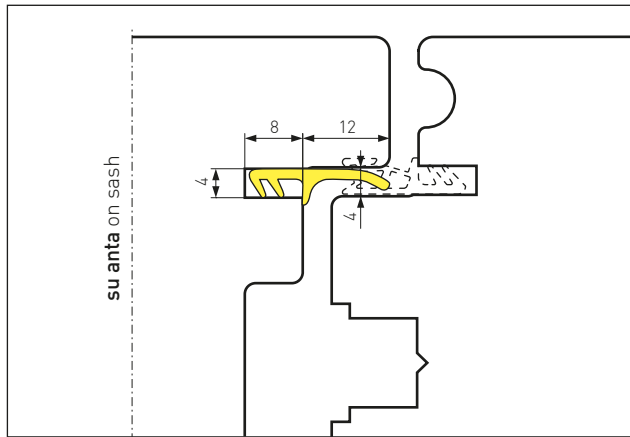



GD-3100020400

GA-3320020190

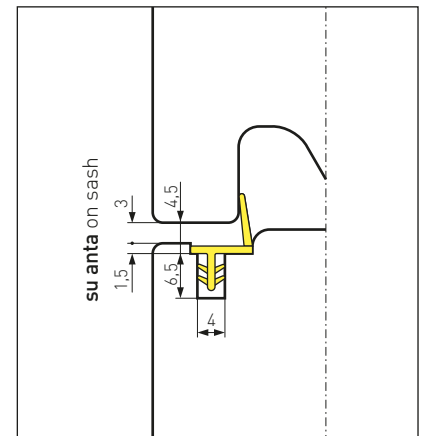
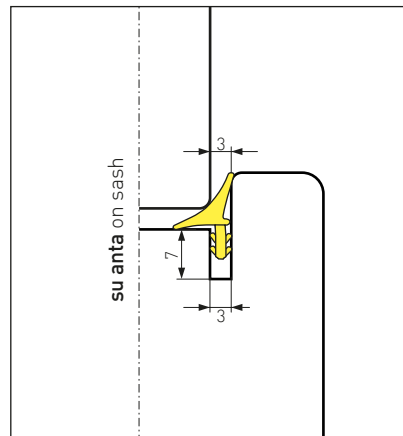
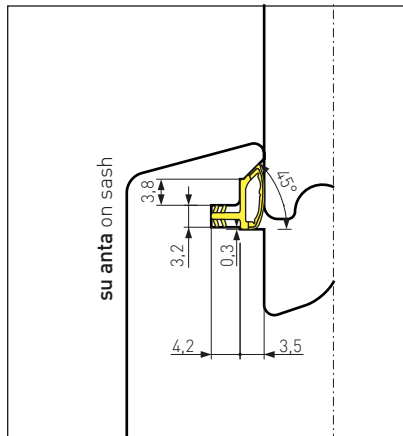
GE-4300020450





GA-8300010300 *			COLORE COLOUR	CF PK	↘ monoestruso mono-extruded ↘ aria 3 mm battuta 10 mm cava 3,5x6 mm
	TPV	GAB8300010300	bianco white	300 ML	

GE-8300010250 *			COLORE COLOUR	CF PK	↘ coestruso co-extruded ↘ aria 3 mm battuta 10 mm cava 3,5x6 mm
	TPV	GEB8300010250	bianco white	250 ML	

GA-8310010340 *			COLORE COLOUR	CF PK	↘ coestruso co-extruded ↘ aria 3 mm battuta 10 mm cava 3,2x7 mm
	TPV	GAB8310010340	bianco white	340 ML	
	TPV	GAM8310010340	marrone brown	340 ML	

GA-8400010300 *			COLORE COLOUR	CF PK	↘ monoestruso mono-extruded ↘ aria 3 mm battuta 10 mm cava 3,5x6 mm
	TPV	GAB8400010300	bianco white	300 ML	

GE-8400010250 *			COLORE COLOUR	CF PK	↘ coestruso co-extruded ↘ aria 3 mm battuta 10 mm cava 3,5x6 mm
	TPV	GEB8400010250	bianco white	250 ML	

GE-8460010250 *			COLORE COLOUR	CF PK	↘ coestruso co-extruded ↘ aria 3 mm battuta 10 mm cava 3,5x6 mm
	TPV	GEB8460010250	bianco white	250 ML	



ATTENZIONE: TUTTE LE GUARNIZIONI PORTE IN TPV SONO DISPONIBILI * FINO A ESAURIMENTO SCORTE
 PLEASE NOTE THAT ALL GAKETS FOR DOORS MADE OF TPV ARE AVAILABLE * WHILE SUPPLIES LAST

GE-8470010270 *			COLORE COLOUR	CF PK	↘ coestruso co-extruded ↘ aria 4 mm battuta 10 mm cava 3x8 mm
	TPV	GEM8470010270	marrone brown	270 ML	

GE-8480010250 *			COLORE COLOUR	CF PK	↘ coestruso co-extruded ↘ aria 3-4 mm battuta 9-10 mm cava 3x8 mm
	TPV	GEM8480010250	marrone brown	250 ML	

GE-8500010250 *			COLORE COLOUR	CF PK	↘ coestruso co-extruded ↘ aria 3 mm battuta 10 mm cava 3,5x6 mm
	TPV	GEB8500010250	bianco white	250 ML	



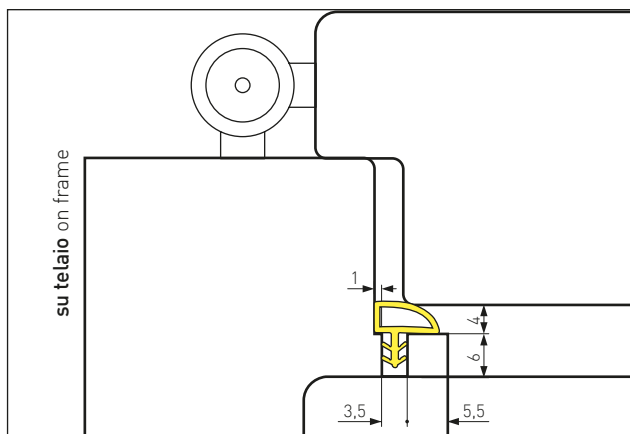

GA-8300010300



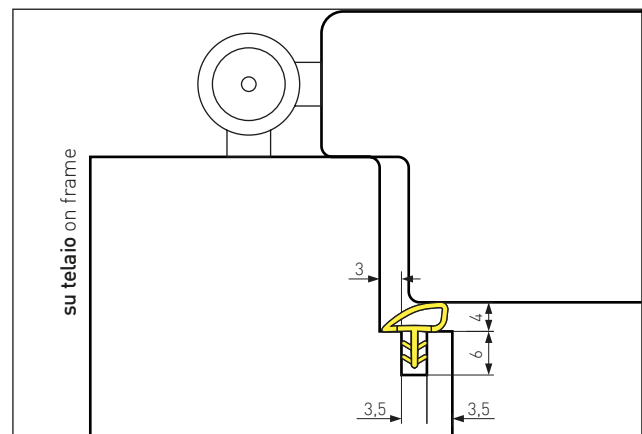

GE-8460010250



GE-8300020250			COLORE COLOUR	CF PK	↘ coestruso co-extruded ↘ aria 3 mm battuta 10 mm cava 3,5x6 mm
	PVC	GEB8300020250	bianco white	250 ML	
	PVC	GEM8300020250	marrone brown	250 ML	

GA-8310020340			COLORE COLOUR	CF PK	↘ monoestruso mono-extruded ↘ aria 3 mm battuta 10 mm cava 3,2x7 mm
	PVC	GAB8310020340	bianco white	340 ML	
	PVC	GAM8310020340	marrone brown	340 ML	

GA-8400020300			COLORE COLOUR	CF PK	↘ monoestruso mono-extruded ↘ aria 3 mm battuta 10 mm cava 3,5x6 mm
	PVC	GAB8400020300	bianco white	300 ML	
	PVC	GAM8400020300	marrone brown	300 ML	

GE-8470020270			COLORE COLOUR	CF PK	↘ coestruso co-extruded ↘ aria 4 mm battuta 10 mm cava 3x8 mm
	PVC	GEB8470020270	bianco white	270 ML	
	PVC	GEM8470020270	marrone brown	270 ML	

GE-8500020250			COLORE COLOUR	CF PK	↘ coestruso co-extruded ↘ aria 3 mm battuta 10 mm cava 3,5x6 mm
	PVC	GEB8500020250	bianco white	250 ML	
	PVC	GEM8500020250	marrone brown	250 ML	

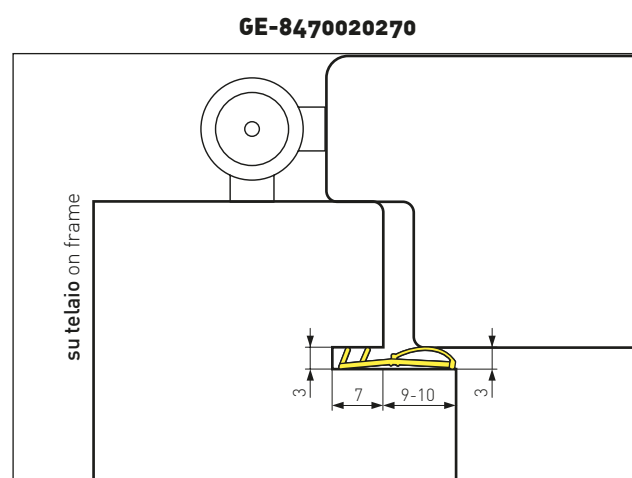
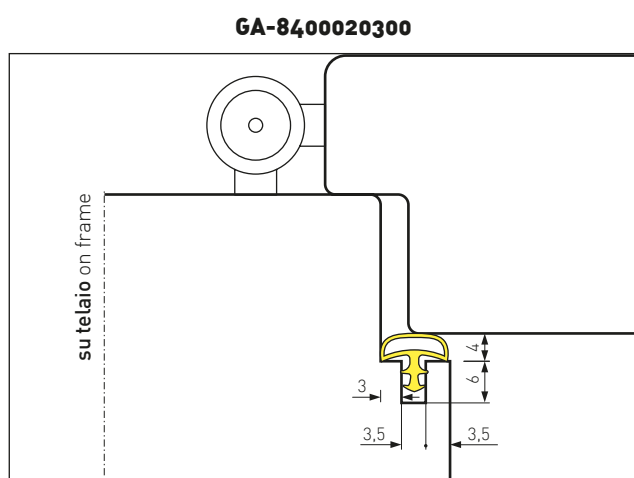

PERCHÈ IN PVC?

Costo contenuto e versatilità d'impiego rendono il PVC uno dei materiali plastici più diffusi. Le mescole hanno proprietà chimico-fisiche diversificate e permettono di ottenere coestrusioni di durezza e colori diversi. Inoltre, offrono la possibilità di estrarre geometrie complesse difficilmente realizzabili con altri materiali plastici. Ideali per uso interno, le guarnizioni in PVC sono altamente performative in termini di resilienza, elasticità e resistenza all'invecchiamento.

Low price and versatility in use make PVC one of the most common plastic materials. Blends have different chemical-physical features and allow to produce coextrusion of different colours and hardness.

Moreover, PVC offers the chance to extrude complex geometries not easy to be produced with other plastic materials. Perfect for interiors, PVC gaskets are highly performative in terms of resilience, elasticity and resistance to ageing.

ATTENZIONE: tutte le guarnizioni porte in TPV sono disponibili fino a esaurimento scorte. Come indicato, alcune guarnizioni porte vengono sostituite dalla variante in PVC.

PLEASE NOTE that all gaskets for doors made of TPV are available while supplies last. As specified, some gaskets for doors will be substituted with PVC version.

GUARNIZIONI SPECIALI
SPECIAL GASKETS

GA-3630010300 FERMAVETRO GLASS GASKET		COLORE COLOUR	CF PK	↘ aria 3 mm battuta 3 mm	
	TPV	GAB3630010300	bianco white		300 ML
	TPV	GAM3630010300	marrone brown		300 ML
	TPV	GAN3630010300	nero black		300 ML

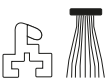
GAX8610010322 SPAZZOLINO BRUSH STRIP		COLORE COLOUR	CF PK	↘ aria 12 mm cava 3x7 mm	
	PVC	GAX8610010322	bianco white		322 ML
	TPV				

GUARNIZIONE IN SILICONE: RISTRUTTURAZIONE VECCHIE FINESTRE
SILICONE GASKET: RENOVATION ON OLD WINDOWS

GS-6350010200		COLORE COLOUR	CF PK	↘ monoestruso mono-extruded ↘ aria 5-6 mm cava 3x5 mm	
	SILI- CONE	GSB6350010200	bianco white		200 ML
		GSM6350010200	marrone brown		200 ML
		GST6350010200	trasparente transparent		200 ML

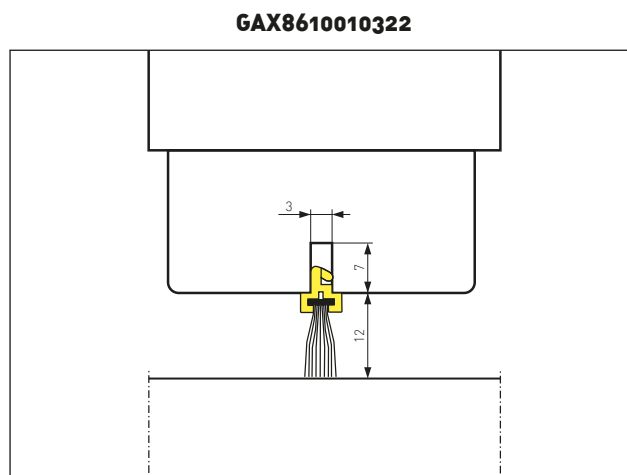
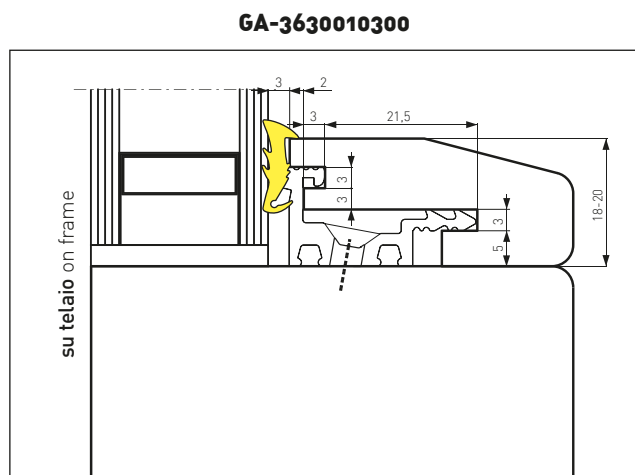

ACCESSORI GUARNIZIONI
GASKETS ACCESSORIES

4104/VR		FORBICI PER GUARNIZIONI SCISSORS FOR GASKETS		CF PK	
	4104/VR	taglio a V V cutting	1 PZ	↘ su anta on sash	

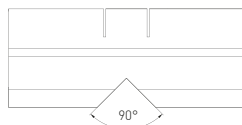
4104/YR		FORBICI PER GUARNIZIONI SCISSORS FOR GASKETS		CF PK	
	4104/YR	taglio a Y Y cutting	1 PZ	↘ su telaio on frame	

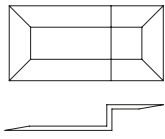
FP-512A010200		TERMINALE END COVER	COLORE COLOUR	CF PK
	TPE	FPB512A010200	bianco white	200 PZ
	TPE	FPN512A010200	marrone brown	200 PZ
	TPE	FPS512A010200	nero black	200 PZ

→ terminale per guarnizione aria 5 mm
su chiusura centrale
end cover for gasket (kerft 5 mm)
for two sashes window

→ **APPLICAZIONE A**
APPLICABLE TO
G--512

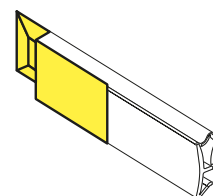
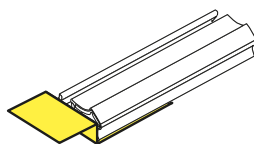
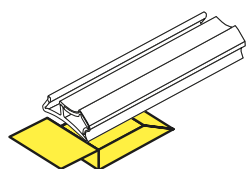

PRG	311	A	01	0024	GOCCIOLATOI
					WEATHER BARS
		colore colour		quantità confezione quantity package	
		A = argento silver B = bronzo chiaro light bronze C = bronzo scuro dark bronze F = bianco white H = bronzo medio middle bronze	revisione review		
		profilo alluminio aluminium profile			
		articolo item			

PRT	290	A	01	0024	SOGLIE
					THRESHOLDS
		colore colour		quantità confezione quantity package	varianti colori other colours A = argento + ABS nero silver + ABS black G = argento + ABS grigio silver + ABS grey F = bianco + ABS nero white + ABS black
		A = argento silver B = bronzo chiaro light bronze C = bronzo scuro dark bronze F = bianco white H = bronzo medio middle bronze	revisione review		negli articoli for items PRT028-020024 PRT029-020024 PRT038-010024
		profilo alluminio aluminium profile			
		articolo item			

GC	M	512	004	0220	GUARNIZIONI
					GASKETS
		colore colour		quantità confezione quantity package	le guarnizioni sono realizzate con diversi materiali, come indicato in tabella gaskets are made of different materials as specified in the grid
		B = bianco white G = grigio grey M = marrone brown N = nero black T = trasparente transparent	revisione review		materiali guarnizioni gaskets materials PVC SILICONE TP-S TPE TPV
		profilo guarnizione gasket profile			
		articolo item			

ARTICOLO ARTICLE	CF PK	KG/CF KG/PK			
GOCCIOLATOI WEATHER BARS			↓	↓	↓
PRG311-010024	24 ML	9 KG	GA-1860010220	220 ML	13 KG
PRG313-010024	24 ML	10 KG	GA-2060010220	220 ML	14 KG
PRG317-010024	24 ML	11 KG	GA-9190020215	215 ML	8 KG
PRG318-010024	24 ML	10 KG	GA-8600020200	200 ML	5 KG
PRG333-010024	24 ML	9 KG	GA-9100030450	450 ML	10 KG
PRG334-010024	24 ML	8 KG	GE-5040030400	400 ML	17 KG
PRG367-010024	24 ML	9 KG	GA-9070020480	480 ML	13 KG
PRG335-010024	24 ML	5 KG	GA-9080020480	480 ML	14 KG
SOGLIE THRESHOLDS			GA-4450010350	350 ML	13 KG
PRG024-010024	24 ML	16 KG	GC-4110020320	320 ML	12 KG
PRG025-010024	24 ML	17 KG	GD-4110010300	300 ML	12 KG
PRG290-010024	24 ML	12 KG	GC-4140020240	240 ML	12 KG
PRG289-010024	24 ML	17 KG	GC-4150020250	250 ML	12 KG
PRG028-010024	24 ML	17 KG	GD-4150010240	240 ML	12 KG
PRG029-010024	24 ML	19 KG	GA-4180010225	225 ML	12 KG
PRT290-010024	24 ML	12 KG	GC-4180020200	200 ML	12 KG
PRT289-010024	24 ML	15 KG	GA-5150010225	225 ML	13 KG
PRT027-010024	24 ML	13 KG	GD-3100020400	400 ML	12 KG
PRT028-010024	24 ML	14 KG	GA-3120030300	300 ML	12 KG
PRT028-020024	24 ML	14 KG	GA-3125030300	300 ML	11 KG
PRT029-010024	24 ML	17 KG	GA-3310020100	100 ML	10 KG
PRT029-020024	24 ML	15 KG	GA-3320020190	190 ML	10 KG
GUARNIZIONI GASKETS			GE-4300020450	450 ML	12 KG
GC-5120040220	220 ML	9 KG	GA-8300010300	300 ML	9 KG
GL-5120010220	220 ML	9 KG	GE-8300010250	250 ML	10 KG
GD-5120030280	280 ML	10 KG	GA-8400010300	300 ML	9 KG
GC-6040030400	400 ML	11 KG	GE-8400010250	250 ML	10 KG
GL-6040010400	400 ML	10 KG	GE-8460010250	250 ML	10 KG
GC-6100030340	340 ML	13 KG	GE-8470010270	270 ML	10 KG
GL-6100010340	340 ML	14 KG	GE-8480010250	250 ML	10 KG
GD-6100020310	310 ML	10 KG	GE-8500010250	250 ML	11 KG

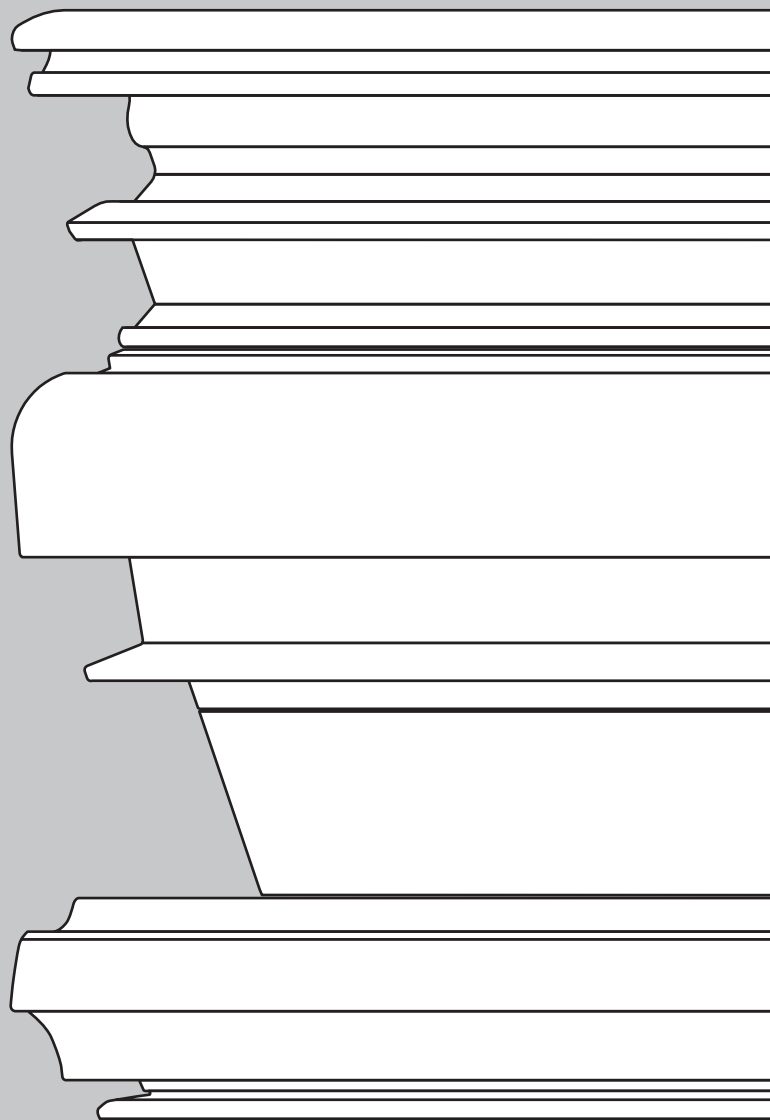

DGT SRL

ACCESSORI CASCADING FREUD

SISTEMI E TECNOLOGIE PER LA LAVORAZIONE DEL LEGNO

Via San Damiano, 3 - 60020 Polverigi (AN)

t. + 39 071 9069517 - f. + 39 071 9069517

dgtsrl@gmail.com